

JBC

www.jbctools.com

	Page
English	2
Español	20
Deutsch	38
中文	54



Precision Soldering Station

Ref. CD-SE

Packing List

The following items should be included:

CD Control Unit 1 unit
Ref. CD-1E (120V)
CD-2E (230V)
CD-9E (100V)



Precision Purpose Handle 1 unit
Ref. T210-A



Power Cord 1 unit
Ref. 0009417 (100V/120V)
0009401 (230V)



Cartridges 2 units
Ref. C210001 (x1)
C210008 (x1)



Brass Wool 1 unit
Ref. CL6210

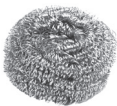

Sponge 1 unit
Ref. S0354



Manual 1 unit
Ref. 0016876

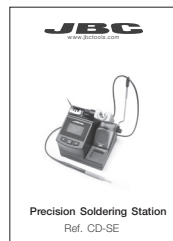

Features

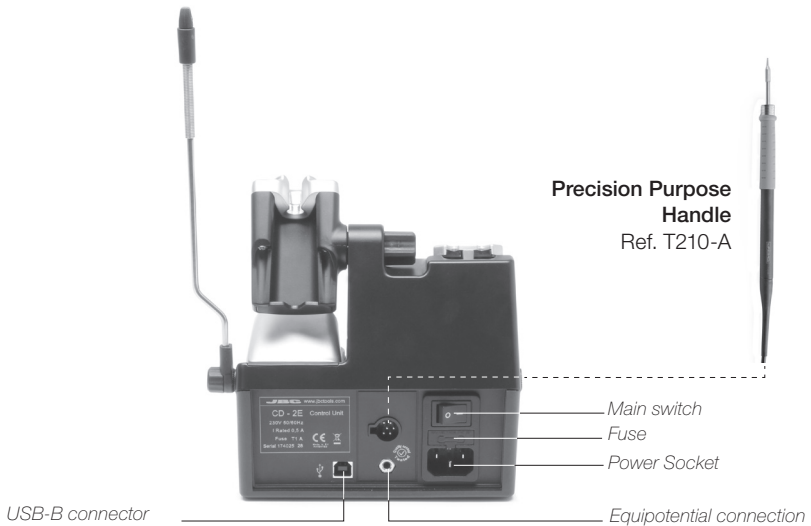

Adjustable stand

Adjust the tool stand to suit your work position.

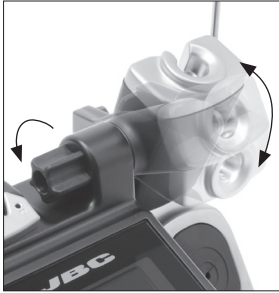

Cable collector (Ref. CC3702)

Fix the cable on the collector so that the working area is free of cable.

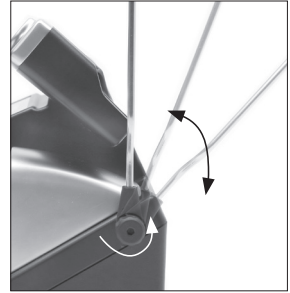
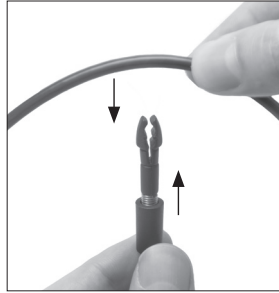

Tip Cleaner

Select the option to suit your needs and improve the thermal transfer of the tip.

Splashguard

Ref. 0017576

When using the brass wool, it prevents splashing of solder particles

Antisplash Membrane

Ref. 0017574

Prevents splashing and keeps the work area clean.

Brass Wool

Ref. CL6210

Very effective cleaning method. Leaves a small layer of solder on the tip, preventing oxidation between cleaning and rewetting.

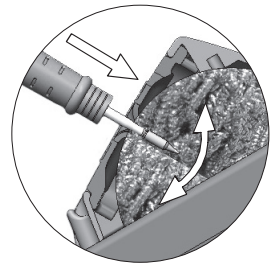
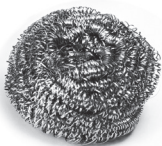

If the tip is very dirty, JBC first recommends cleaning it with the wiper to remove excess solder.

Wiper

Ref. CL0160

A temperature resistant receptacle for removing excess solder by gently tapping or wiping.

Removing the splashguard:

1. Unlock the splashguard.



2. Lift off.



More cleaning options (not supplied):

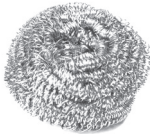

Inox Wool

Ref. CL6205

Provides a superior cleaning of the tip.

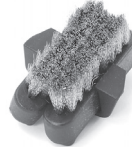

Metal Brush

Ref. CL6220

When used carefully, it provides a more thorough cleaning.

Wiper

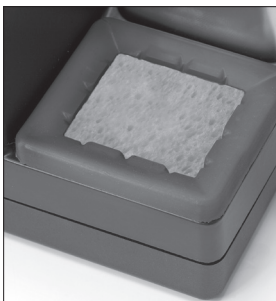

Sponge

Ref. S0354

The least harmful cleaning method. Keep the sponge damp with distilled water to avoid tip wear.

Tapping:

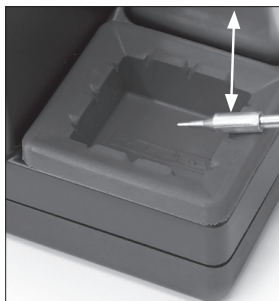

Tap gently to remove excess solder.

Wiping:

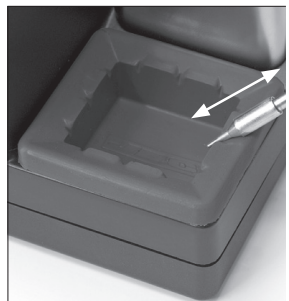

Use the slots to remove remaining particles.

Compatible Handles

For general use

Works with C245 Cartridge range

General Purpose Handle

Ref. T245-A



Blue Handle

Ref. T245-PA



Non-slip Handle

Ref. T245-B



Soft Thermal Insulator Handle

Ref. T245-C



Easily replace the Grips for T245-A and T245-C using the slip-on tabs (Ref. 0016057 Supplied with 4 grips).

1. Inserting tabs

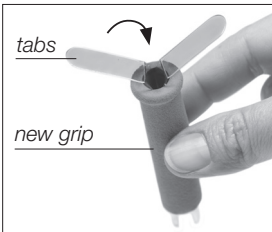

Insert the slide-on tabs into the new grip.

2. Inserting handle

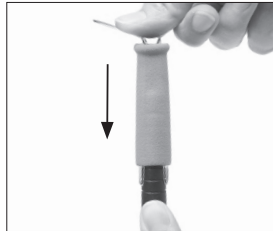

Push the grip with the tabs onto the handle.

3. Removing tabs

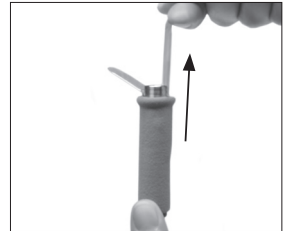

To remove the tabs, hold the grip and pull them out. Use a pliers if necessary.

Note: All models are supplied with a 1.5 m cable.

For precision use

Works with C210 Cartridge range

Precision Purpose Handle

Ref. T210-A



Blue Precision Handle

Ref. T210-PA



Blue grip to easily distinguish it from other handles

For greater demands

Important: Only use C245 cartridges when working with a CD station.

For intensive soldering jobs requiring continuous high thermal power. They feature good thermal insulation and a screw which fixes the cartridge and prevents it rotating.

HD Purpose Handle

Ref. T470-A



HD Purpose Handle + 3m cable

Ref. T470-SA

Tri-lobed HD Handle

Ref. T470-ZA

For better handling of the tool.



Thermal Insulator HD Handle

Ref. T470-FA



Thermal Insulator HD Handle + 3m cable

Ref. T470-MA

Foam

Note: All models are supplied with a 1.5 m cable except those specified with 3 m.

Quick Tip Changer

Save time and change cartridges safely without switching the station off.

1. Removing

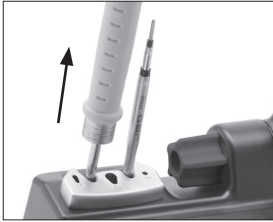

Place the handpiece in the extractor and pull to remove the cartridge.

2. Inserting

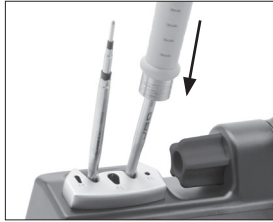

Place the handpiece on top of the new cartridge and press down slightly.

3. Fixing

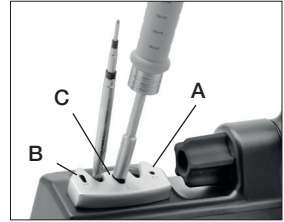

Use the holes for fixing the cartridge* as follows:
A. For straight C210.
B. For curved C210.
C. For C245.

*Important

It is necessary to insert the cartridges as far as the mark for a proper connection.

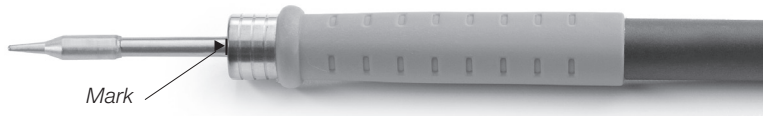

Compatible cartridges

The CD stations work with C245 cartridges and T245/T470 handpieces or C210 cartridges with T210 handpieces. Find the model that best suits your soldering needs in www.jbctools.com



Round



Chisel



Round bent



Bevel

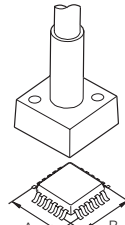

Special models

USB Connector

Download the latest software from our website to update your soldering station.

JBC Updater

www.jbctools.com/software.html

Update the station software via USB connection:

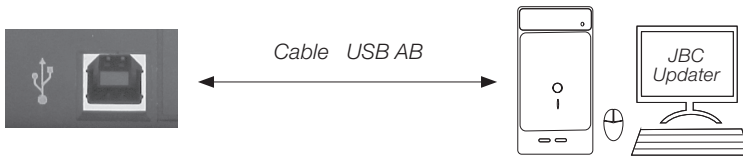

JBC Manager

www.jbctools.com/manager.html

Manage and monitor as many stations as your PC can handle by using the JBC Manager. You can export data to another PC.

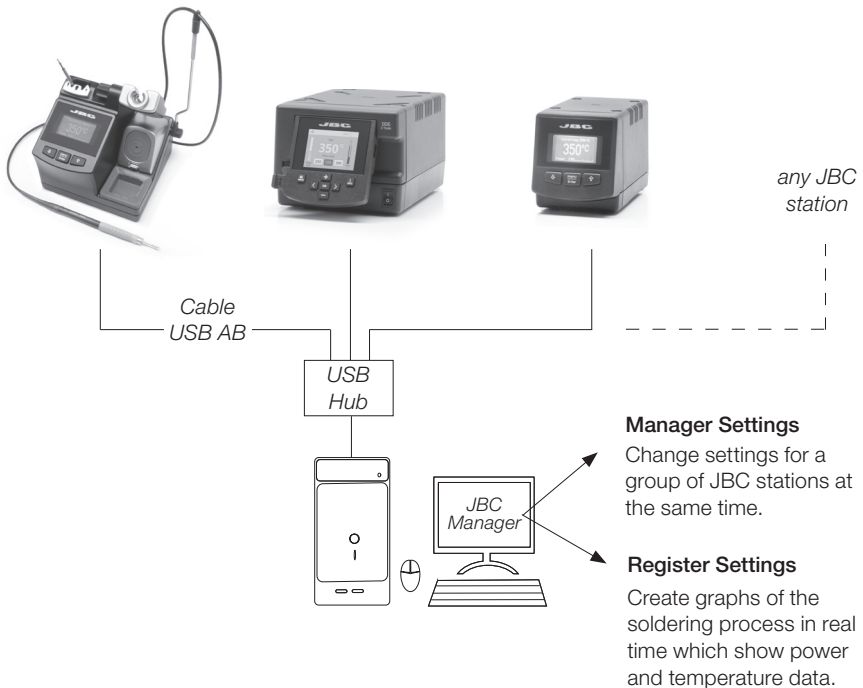

Operation

The JBC Exclusive Heating System

This revolutionary technology is able to recover tip temperature extremely quickly. This allows the user to work at a lower temperature. As a result, tip life increases by 5.

1. Work



When the tool is lifted from the stand the tip will heat up to the selected temperature.

2. Sleep



When the tool is in the stand, the temperature falls to the preset Sleep temperature.

3. Hibernation

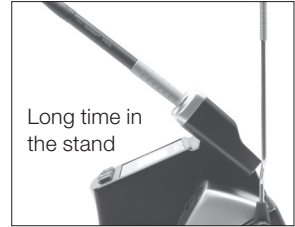

After longer periods of inactivity, the power is cut off and the tool cools down to room temperature.

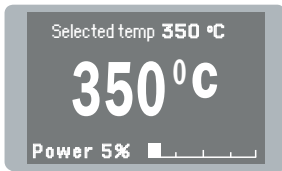

- Change temperature (from 90 to 450°C)
- Select temperature levels
- Fix one temperature



- Change Sleep temperature
- Set Sleep delay (from 0 to 9 min or no Sleep)



- Change Hibernation delay (from 0 to 35 min)

Control Process

Work Screen

The work screen provides useful information of tool status in real time.

The Work Screen displays the following information:

- Fixed temp. 350 °C**: Displays a specific fixed temp.
- Levels °C 270 350 400**: Shown when you have selected temp. levels. The values must be adjusted for the task.
- Selected temp. 350 °C**: "Temp. Adjust" parameter. It provides a more precise adjustment between the selected temp and the actual one.
- 350 °C**: Large display of the selected temperature.
- 10**: Temperature adjustment value.
- Power 5%**: Power level indicator.
- Navigation buttons**: Down arrow, Menu/Enter, and Up arrow.

Menu Screen

Original PIN: 0105

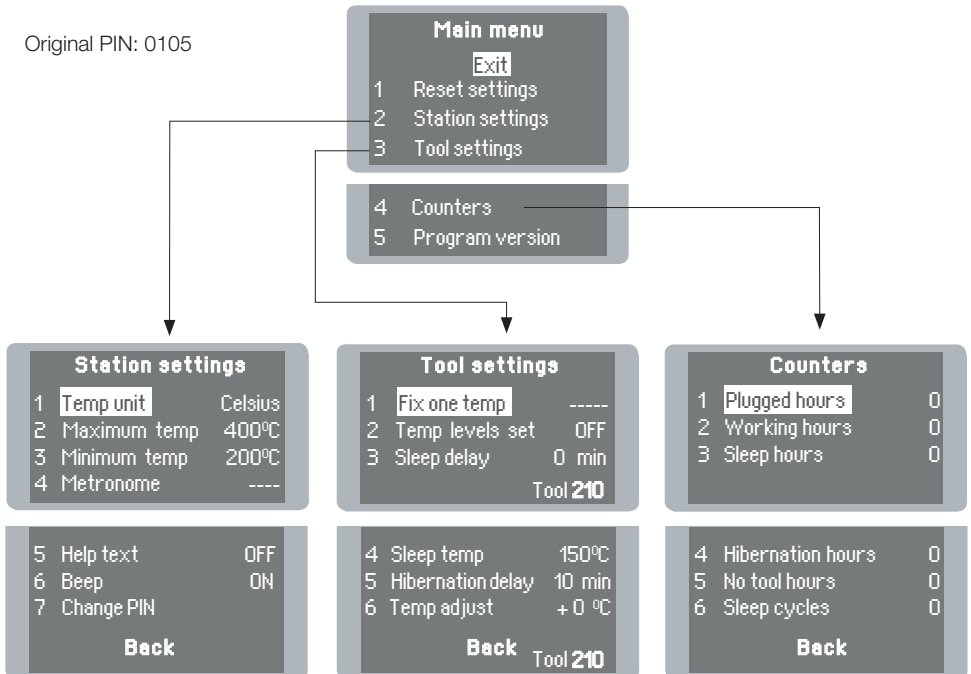

Parameters

Be careful when using these parameters. They can reduce tip life if not used properly. Please follow the recommended guidelines:

Station Settings

Parameter description	Recommendations	Warnings
Temperature unit Celsius (°C) or Fahrenheit (°F)	N/a	
Maximum temperature Set the maximum temperature to work with. Max. temp by default is 400°C (750°F). This is considered high enough to work with most lead-free applications.	The station temperature range is 90-450°C (190-840°F). Change the temperature limits when working with less common applications such as low / high melting point soldering (HMP) or plastics (e. g. riveting).	 In most cases, working with temperatures over 400°C (750°F) can damage the PCB and its components. Even in short time periods of tip contact with the soldering joint, the flux may not work properly and could seriously reduce tip life. If the solder joint requires more power (e.g. multilayered or high dissipation boards), JBC strongly recommends using other aids like preheaters.
Minimum temperature Set the minimum temperature to work with. Min. temp. by default is 200°C (392°F). This is considered to be a proper starting point for leaded applications.		
Metronome This activates a beep sound. Frequencies vary from 1 to 50 seconds.	Useful for setting a work rate in repetitive jobs. The beep lets you know the length of time the tip must be in contact with the soldering joint.	N/a
Help text Activate this parameter to receive info from the system.	N/a	N/a
Beep Enable/disable the beep sound of the keypad.	N/a	N/a
Change pin Change the default security PIN number (0105).	The PIN must be entered every time a parameter is changed.	N/a

Tool Settings

Parameter description	Recommendations	Warnings
<p>Fix one temperature Fix a value within the temperature range of the station (90-450°C/190-840°F).</p>	Ideal for soldering more than one component at a specific temperature. The station will reject any attempt to change the temperature.	N/a
<p>Temperature levels set Similar to "Fix one temp" parameter. In this case, the user can set up to 3 values for different power requirements.</p>	This allows a quick change between 3 different temperatures. Set them according to the allowed values for your soldering applications.	N/a
<p>Sleep delay Set the time that the tool will remain at the selected temperature when in the stand before entering sleep mode. The tip temperature will then drop to the Sleep temperature.</p>	Because our tools reach the working temperature from the default Sleep mode in only a few seconds, this parameter is preset to 0 min. Once the tool is returned to the stand the temperature will automatically drop to the sleep temperature, extending tip life and avoiding oxidation. Retinning the tip before placing the tool in the stand will protect the tip and extend its life.	<p>Setting these parameters to higher values will unnecessarily accelerate oxidation and shorten tip life especially when working with temperatures up to 450°C (840°F).</p>
<p>Sleep temperature This is the set temperature the tip reaches when returned to the stand.</p>	The sleep temperatures are set to achieve a balance between preventing oxidation and reaching the working temperature in a few seconds.	

Tool Settings

Parameter description

Recommendations

Warnings

Hibernation Delay

Set the time the tool will remain at Sleep temperature before entering the Hibernation mode. At this time, the power supply is cut off and the tip remains at room temperature.

This function completely protects the tip from oxidation during long periods of inactivity while the tool is in the stand.
Retinuing the tip before placing the tool in the stand also helps prevent oxidation and extends the life of the tip.

 Increasing the default value will accelerate oxidation and shorten the tip life.

Temp Adjustment

It provides a more precise adjustment between the selected temperature and the actual one.

Set values within $\pm 50^{\circ}\text{C}$ ($\pm 90^{\circ}\text{F}$) to achieve zero error. JBC strongly recommends the use of TID-A or TIA-A Thermometers to obtain precise readings.

 When the user changes the cartridge type, the parameter should be reset to $0^{\circ}\text{C}/\text{F}$ or to the value needed for this cartridge. E.g. If a correction of $+20^{\circ}\text{C}$ ($+36^{\circ}\text{F}$) is set for the C245966 (thick type) and then the user changes the cartridge for a C245030 (which is thinner) without resetting, they would be working at a temperature of $+20^{\circ}\text{C}$ ($+36^{\circ}\text{F}$) lower for the C245030 which does not need any temperature adjustment.

Maintenance

Before carrying out maintenance, always allow the equipment to cool.

- Clean the station screen with a glass cleaner or a damp cloth.
- Use a damp cloth to clean the casing and the tool. Alcohol can only be used when cleaning the metal parts.
- Periodically check that the metal parts of the tool and stand are clean so that the station can detect the tool status.
- Maintain tip surface clean and tinned prior to storage in order to avoid tip oxidation. Rusty and dirty surfaces reduce heat transfer to the solder joint.
- Periodically check all cables and tubes.
- Replace a blown fuse as follows:



1. Pull off the fuse holder and remove the fuse. If necessary use a tool to lever it off.

2. Insert the new fuse into the fuse holder and return it to the station.

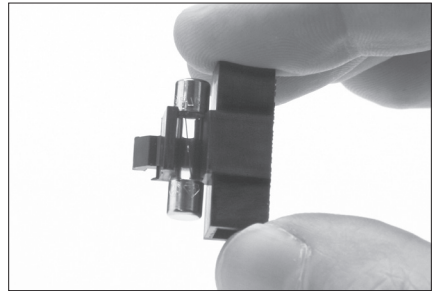
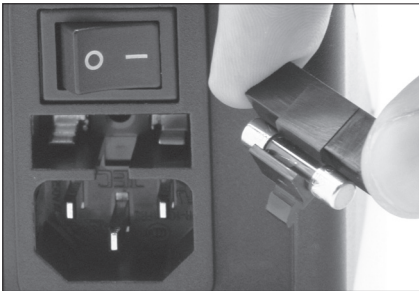

- Replace any defective or damaged pieces. Use original JBC spare parts only.
- Repairs should only be performed by a JBC authorized technical service.

Safety



It is imperative to follow safety guidelines to prevent electric shock, injury, fire or explosion.

- Do not use the units for any purpose other than soldering or rework. Incorrect use may cause fire.
- The power cord must be plugged into approved bases. Be sure that it is properly grounded before use. When unplugging it, hold the plug, not the wire.
- Do not work on electrically live parts.
- The tool should be placed in the stand when not in use in order to activate the sleep mode. The soldering tip, the metal part of the tool and the stand may still be hot even when the station is turned off. Handle with care, including when adjusting the stand position.
- Do not leave the appliance unattended when it is on.
- Do not cover the ventilation grills. Heat can cause inflammable products to ignite.
- Use a "non residue" classified flux and avoid contact with skin or eyes to prevent irritation.
- Be careful with the fumes produced when soldering.
- Keep your workplace clean and tidy. Wear appropriate protection glasses and gloves when working to avoid personal harm.
- Utmost care must be taken with liquid tin waste which can cause burns.
- This appliance can be used by children over the age of eight and also persons with reduced physical, sensory or mental capabilities or lack of experience provided that they have been given adequate supervision or instruction concerning use of the appliance and understand the hazards involved. Children must not play with the appliance.
- Maintenance must not be carried out by children unless supervised.

Specifications

CD-1SE 120V 50/60Hz. Input fuse: 2A. Output: 23,5V. Control Unit model: **CD-1E**

CD-2SE 230V 50/60Hz. Input fuse: 1A. Output: 23,5V. Control Unit model: **CD-2E**

CD-9SE 100V 50/60Hz. Input fuse: 2A. Output: 23,5V. Control Unit model: **CD-9E**

- Weight: 2.7 Kg (5.9 lb)
- Dimensions: 150 x 175 x 145 mm
- Output Peak Power CD-SE: 40W
- Temperature Range: 90-450°C (190°-840°F) (±5%)
- Idle Temp. Stability (still air): ±1.5 °C / ±3 °F
- Tip to ground resistance: <2 ohms
- Tip to ground voltage: <2mV RMS
- Ambient operating temp: 10-40 °C / 50-104 °F
- USB connector station-PC

Complies with CE standards

ESD protected housing "skin effect"

Estación soldadora de precisión

Ref. CD-SE

Composición

Los siguientes artículos deben estar incluidos:

CD Control Unit

Unidad de Control CD 1 unidad
Ref. CD-1E (120V)
CD-2E (230V)
CD-9E (100V)



Precision Purpose Handle

Mango para aplicaciones de precisión .. 1 ud
Ref. T210-A



Power Cord

Cable de Red 1 unidad
Ref. 0009417 (100V/120V)
0009401 (230V)



Cartridges

Cartuchos 2 unidades
Ref. C210001 (x1)
C210008 (x1)



Brass Wool

Lana de latón 1 unidad
Ref. CL6210

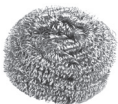

Sponge

Espanja 1 unidad
Ref. S0354



Manual

..... 1 unidad

Ref. 0016876

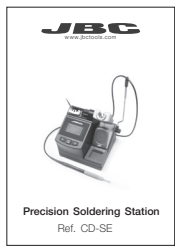

Soporte Ajustable

Ajuste el soporte de la herramienta para adaptarlo a su posición de trabajo.

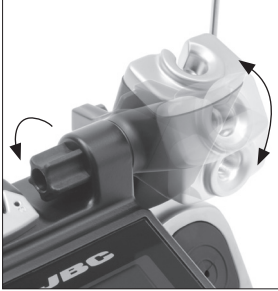

Recogecable (Ref. CC3702)

Coloque el cable en el recogedor para mantener ordenada su área de trabajo.

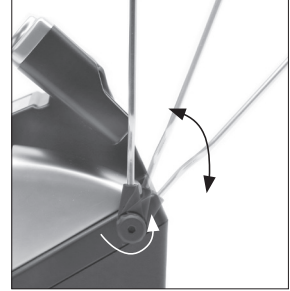
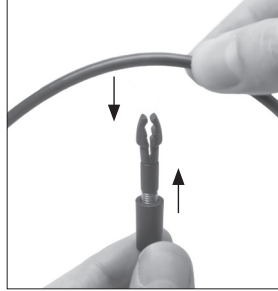

Limpiador de puntas

Elija la opción que se ajuste mejor a sus necesidades y mejore la transferencia térmica de la punta.

Splashguard Protector anti-salpicaduras

Ref. 0017576

Protege la estación de las salpicaduras cuando se utiliza la lana de latón.

Antisplash Membrane

Membrana protectora

Ref. 0017574

Protege el área de trabajo de salpicaduras en el momento de limpiar la punta.

Brass Wool

Lana de latón

Ref. CL6210

Método muy eficaz.

Deja una pequeña capa de estaño en la punta para prevenir la oxidación entre la limpieza y la rehumectación.

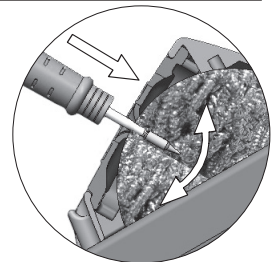

Antes de utilizar la lana se recomienda eliminar el exceso de estaño acumulado en la punta con el limpiador.

Wiper Limpiador

Ref. CL0160

Receptáculo resistente a la temperatura que permite que se pueda eliminar el exceso de soldadura golpeando suavemente o limpiando.

Si necesita extraer el protector anti-salpicaduras, siga los siguientes pasos:

1. Gire el pomo.



2. Retire el protector anti-salpicaduras.



Otras opciones de limpieza (no incluidas):

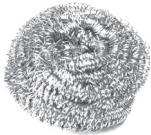

Inox Wool

Lana inoxidable

Ref. CL6205

Proporciona una limpieza superior de la punta.

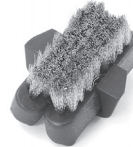

Metal Brush

Cepillo de metal

Ref. CL6220

Si se usa con cuidado, proporciona una limpieza más profunda.

Wiper Limpiador

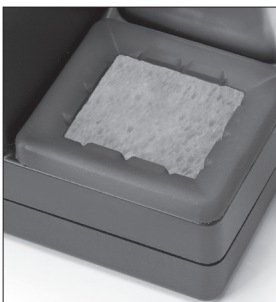

Sponge Esponja

Ref. S0354

El método de limpieza menos dañino. Mantenga la esponja húmeda con agua destilada cuando trabaje para evitar el desgaste de la punta.

Golpeteo:

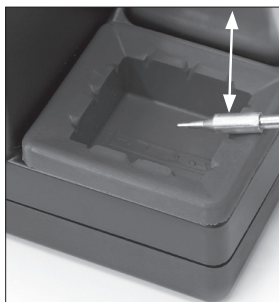

Sacuda ligeramente los cartuchos para soltar el exceso de estaño.

Limpieza:

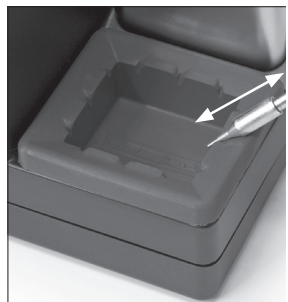

Utilice las ranuras para eliminar las partículas adheridas a la punta.

Mangos compatibles

Para uso general

Funciona con la gama de cartuchos C245

General Purpose Handle

Mango para aplicaciones generales

Ref. T245-A

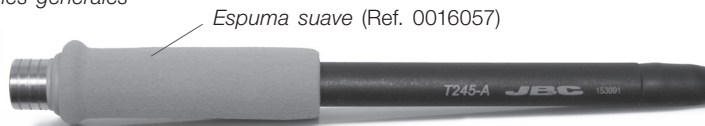

Blue Handle · Mango azul

Ref. T245-PA

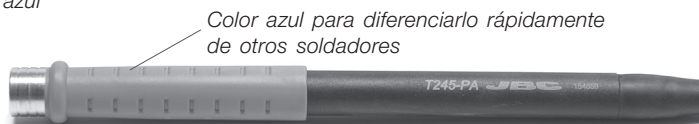

Non-slip Handle · Mango antideslizante

Ref. T245-B



Soft Thermal Insulator Handle · Mango suave con aislamiento térmico

Ref. T245-C



Cambie fácilmente la **empuñadura de los mangos T245-A y T245-C** usando los aplicadores (Ref. 0016057 Se incluyen 4 unidades).

1. Inserte los aplicadores

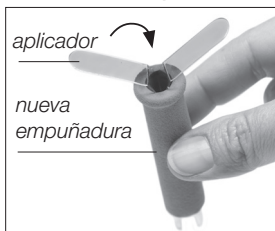

Introduzca los aplicadores en la nueva empuñadura.

2. Inserte el mango

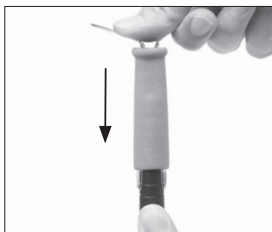

Inserte el conjunto en el mango y empuje hasta que quede bien situado.

3. Quite los aplicadores

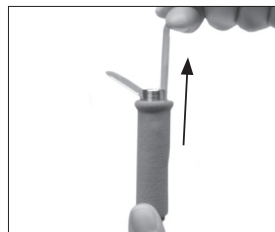

Para extraer los aplicadores agarre la empuñadura y tire hacia arriba (con unos alicates si es necesario).

Nota: Todos los modelos se suministran con un cable de 1,5 m.

Para uso de precisión

Funciona con la gama de cartuchos C210

Precision Purpose Handle · Mango para aplicaciones de precisión

Ref. T210-A



Blue Precision Handle · Mango azul de precisión

Ref. T210-PA



Color azul para diferenciarlo rápidamente de otros soldadores

Para mayores exigencias

Importante: En una estación CD sólo funcionan si se utilizan con cartuchos C245. Indicados en trabajos de soldadura intensivos que requieran una alta potencia térmica continuada. Presentan un diámetro más grande e incorporan un tornillo para fijar el cartucho.

HD Purpose Handle

Mango HD

Ref. T470-A

HD Purpose Handle + 3m cable

Mango HD con cable de 3m

Ref. T470-SA



Tri-lobed HD Handle · Mango HD trilobular

Ref. T470-ZA

Para un mejor control manual de la herramienta.



Thermal Insulator HD Handle

Mango HD con aislamiento térmico

Ref. T470-FA

Thermal Insulator HD Handle + 3m cable

Mango HD con aislamiento térmico con cable de 3m

Ref. T470-MA

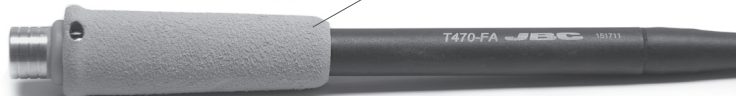

Espuma

Nota: Todos los modelos se suministran con un cable de 1,5 m excepto aquellos indicados con 3 m.

Cambio rápido de cartuchos

Ahorre tiempo y cambie cartuchos con seguridad sin desconectar la estación.

1. Retirar

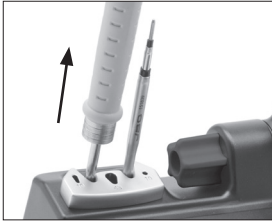

Coloque el lápiz soldador en las ranuras del extractor y tire hacia arriba para retirar el cartucho.

2. Insertar

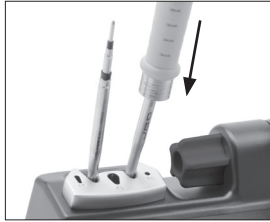

Coloque el lápiz soldador en la parte superior del nuevo cartucho y empuje hacia abajo ligeramente.

3. Fijar

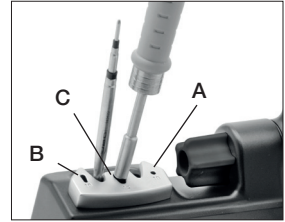

Utilice los agujeros fijadores para ajustar el cartucho*:
A. Para los rectos C210.
B. Para los curvados C210.
C. Para cartuchos C245.

*Importante

Es imprescindible insertar los cartuchos hasta la marca para una conexión correcta.

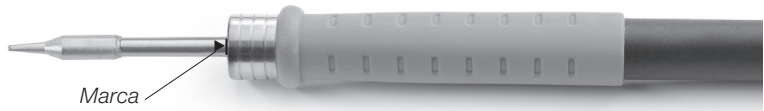

Cartuchos compatibles

Las estaciones CD funcionan con cartuchos C245 y mangos T245/T470 o con cartuchos C210 y mangos T210. Encuentre el modelo que mejor se adapte a sus necesidades en www.jbctools.com



Redondo



Cinzel



Redondo
curvado



Bisel

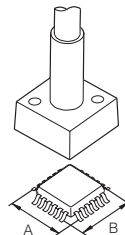

Modelos especiales

Conector USB

Descargue los últimos *softwares* y actualizaciones en nuestra web para mejorar su estación.

JBC Updater · Actualizador JBC

www.jbctools.com/software.html

Actualice el programa (*software*) a través de la conexión USB:



JBC Manager · Gestor JBC

www.jbctools.com/manager.html

Gestione y monitoree tantas estaciones como su ordenador permita utilizando el JBC Manager (*Gestor JBC*). Puede exportar los datos a otros PCs.

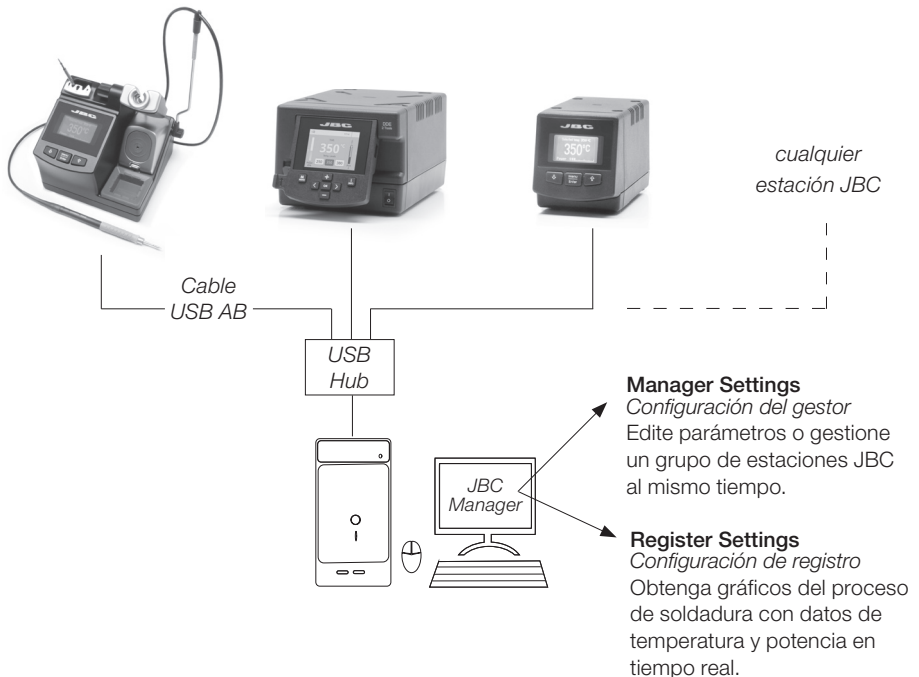

Funcionamiento

El Exclusivo Sistema Calefactor de JBC

Esta tecnología revolucionaria es capaz de recuperar la temperatura extremadamente rápido.

Esto permite al usuario trabajar con temperaturas más bajas.

Y como resultado, la vida de la punta puede incrementarse hasta 5 veces.

1. Trabajo



Quando se levanta la herramienta del soporte, la punta se calentará hasta la temperatura seleccionada.

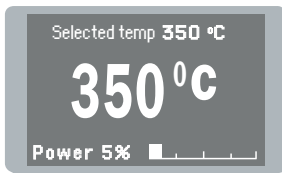

- Cambie la temperatura (de 90 a 450°C)
- Seleccione niveles de temperatura
- Fije una temperatura

2. Sleep



Quando la herramienta está en el soporte, la temperatura se reduce a la temperatura de Sleep predefinida.



- Cambie la temp. de Sleep
- Retrasa el tiempo de entrada al modo Sleep (de 0 a 9 min o no Sleep)

3. Hibernación



Tras largos períodos de inactividad, se corta el suministro de energía y la punta se enfría hasta temperatura ambiente.



- Retrasa el tiempo de entrada al modo Hibernación (de 0 a 35 min)

Control del proceso

Pantalla de trabajo

Se muestra cuando se fija una temperatura específica.

Se muestra cuando se activan los niveles de temperatura. Los valores se deben ajustar según necesidad.

Proporciona información útil del estado de la herramienta en tiempo real.

Se muestra cuando se utiliza "Temp. Adjust", un ajuste más preciso entre la temperatura seleccionada y la real.

Fixed temp. **350 °C**

Levels °C **270 350 400**

Selected temp. **350 °C**

350 °C

-10

Power 5%

↓ Menu Enter ↑

Pantalla de menú

PIN original: 0105

Main menu

- Exit
- 1 Reset settings
- 2 Station settings
- 3 Tool settings
- 4 Counters
- 5 Program version

Station settings

- 1 Temp unit Celsius
- 2 Maximum temp 400°C
- 3 Minimum temp 200°C
- 4 Metronome ----
- 5 Help text OFF
- 6 Beep ON
- 7 Change PIN

Back

Tool settings

- 1 Fix one temp ----
- 2 Temp levels set OFF
- 3 Sleep delay 0 min
- 4 Sleep temp 150°C
- 5 Hibernation delay 10 min
- 6 Temp adjust +0 °C

Back Tool 210

Counters

- 1 Plugged hours 0
- 2 Working hours 0
- 3 Sleep hours 0
- 4 Hibernation hours 0
- 5 No tool hours 0
- 6 Sleep cycles 0

Back

Parámetros

Tenga en cuenta que un uso indebido de los parámetros puede reducir la vida de la punta. Por favor, siga las siguientes indicaciones:

Configuración de la estación (*Station Settings*)

Descripción del parámetro	Recomendaciones	Advertencias
Unidad de temperatura Celsius (°C) o Fahrenheit (°F)	N/a	
Temperatura máxima Seleccione la temperatura máxima de trabajo. Configurado por defecto a 400°C (750°F) ya que se considera un valor suficiente para trabajar con la mayoría de aplicaciones sin plomo.	El rango de temperatura de la estación es 90-450°C (190-840°F). Modifique los límites de temperatura cuando trabaje con aplicaciones menos comunes como son las soldaduras con bajos / altos puntos de fusión o los plásticos (p. ej. riveting).	 En general, trabajar con temperaturas por encima de 400°C (750°F) puede dañar el PCB y los componentes. Incluso en tiempos cortos de contacto de la punta con la soldadura, el flux podría no funcionar correctamente y reducir la vida de la punta. En este caso la soldadura requiere más potencia (p. ej. PCBs multicapa o de gran disipación). JBC recomienda utilizar la ayuda del precalentador.
Temperatura mínima Seleccione la temperatura mínima de trabajo. Configurado por defecto a 200°C ya que se considera un valor adecuado para empezar a soldar con la mayoría de aplicaciones con plomo.		
Metrónomo Permite activar un sonido <i>beep</i> para repetirlo entre 1 y 50 segundos.	Ideal para trabajos repetitivos ya que marca el ritmo de trabajo a seguir. El sonido establece el tiempo de contacto de la punta con la soldadura.	N/a
Texto de ayuda Actívelo para recibir información de la estación.	N/a	N/a
Beep Active el sonido del teclado.	N/a	N/a
Cambie el PIN Permite modificar el código PIN de seguridad (0105).	La estación requiere entrar el PIN cada vez que el usuario entra en el menú para modificar cualquier parámetro.	N/a

Configuración de la Herramienta (*Tool Settings*)

Descripción del parámetro	Recomendaciones	Advertencias
<p>Fijar una temperatura Fije un valor dentro del rango de temperatura de la estación 90-450°C (190-840°F).</p>	<p>Ideal para trabajos en los que se deben soldar más de un componente a una temperatura específica. La estación queda protegida por PIN y deniega cualquier intento de cambio de temperatura.</p>	N/a
<p>Niveles de temperatura Similar al parámetro "Fijar una temperatura". En este caso se pueden configurar 3 valores de temperatura.</p>	<p>Permite conmutar entre diferentes unidades de temperatura definidas por el usuario. Puede configurar hasta 3 temperaturas en función de cada aplicación.</p>	N/a
<p>Retraso de <i>Sleep</i> Configure el tiempo que la herramienta permanecerá a la temperatura seleccionada en el soporte antes de entrar en el modo <i>Sleep</i>. Tras agotarse el tiempo, la temperatura de la punta caerá hasta el valor de <i>Sleep</i>.</p>	<p>Dado que nuestras herramientas pueden alcanzar la temperatura de trabajo desde la temperatura de <i>Sleep</i> en pocos segundos, este parámetro viene preconfigurado a 0 min. Una vez la herramienta se coloque en el soporte, la temperatura de la punta cae automáticamente al valor de <i>Sleep</i>, hecho que alarga su vida útil y reduce la oxidación. Restañar la punta antes de colocar la herramienta en el soporte también ayudará a proteger su recubrimiento y garantizar su larga duración.</p>	<p> Configurar este parámetro con valores más altos acelerará innecesariamente la oxidación y acortará la vida de la punta, especialmente cuando se trabaje con temperaturas de hasta 450°C (840°F).</p>
<p>Temperatura de <i>Sleep</i> Es la temperatura que la herramienta tendrá cuando descanse en el soporte.</p>	<p>Las temperaturas de <i>Sleep</i> están preconfiguradas para conseguir un compromiso entre la prevención de oxidación y la disposición para alcanzar la temperatura de trabajo en pocos segundos.</p>	

Configuración de la Herramienta (*Tool Settings*)

Descripción del parámetro	Recomendaciones	Advertencias
<p>Retraso de Hibernación Configure el tiempo que la herramienta permanecerá en temperatura de <i>Sleep</i> antes de entrar al modo de Hibernación. Configurado por defecto a 10 min. Tras agotarse el tiempo, la estación cortará el suministro de energía y la punta se enfriará hasta temperatura ambiente.</p>	<p>Esta función protege completamente la punta de la oxidación durante largos periodos de inactividad. Es decir mientras la herramienta permanezca en el soporte. Restañar la punta antes de colocar la herramienta en el soporte también ayudará a proteger su recubrimiento y garantizar su larga duración.</p>	<p> Configurar este parámetro con valores más altos que el valor de fábrica acelerará innecesariamente la oxidación y acortará la vida de la punta.</p>
<p>Ajuste de temperatura Permite un ajuste más preciso entre la temperatura seleccionada en la estación y la temperatura real en la punta.</p>	<p>El usuario puede ajustar valores dentro del intervalo $\pm 50^{\circ}\text{C}$ ($\pm 90^{\circ}\text{F}$) hasta conseguir error cero. JBC recomienda usar los termómetros TID-A o TIA-A para obtener lecturas más fiables.</p>	<p> Cuando se cambie de modelo de cartucho, se debe resetear este parámetro a $0^{\circ}\text{C}/\text{F}$ o ajustarlo al cartucho a utilizar. P. ej. Si se establece una corrección de $+20^{\circ}\text{C}$ ($+36^{\circ}\text{F}$) para el modelo C245966 (grueso) y el usuario cambia el cartucho por un C245030 (más fino) sin resetear, el usuario estaría trabajando a 20°C ($+36^{\circ}\text{F}$) de temperatura más baja cuando el modelo C245030 no necesita ningún ajuste de temperatura.</p>

Mantenimiento

Antes de almacenar o de su mantenimiento, desconecte el equipo y déjelo enfriar.

- Use un paño húmedo para limpiar la pantalla del equipo, la carcasa y la herramienta. Solamente utilice alcohol para las partes metálicas.
- Compruebe periódicamente que las partes metálicas de la herramienta y el soporte están limpias así la estación puede detectar el estado de la herramienta y activar los modos *Sleep* o *Hibernation*.
- Mantenga limpia y estañada la superficie de la punta para evitar la oxidación. Las superficies sucias reducen la transferencia térmica a la soldadura.
- Revise la conexión de cables y/o tubos.
- Cambie el fusible fundido de acuerdo a las siguientes instrucciones:

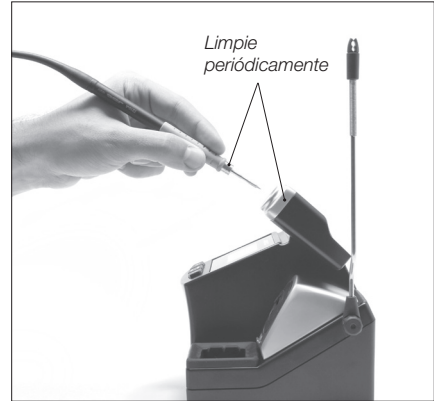

1. Retire el fusible tirando de la tapa negra. Si fuera necesario, utilice una palanca.

2. Coloque el nuevo fusible en su sitio presionando ligeramente.

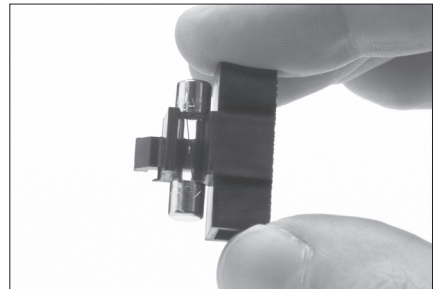
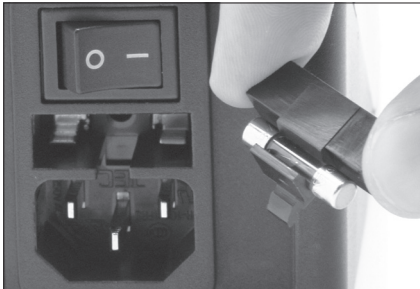

- Cambie cualquier pieza defectuosa o dañada. Utilice solamente recambios originales de JBC.
- Cualquier reparación sólo podrá ser realizado por un servicio técnico oficial JBC.

Seguridad



Es necesario cumplir estas normas de seguridad para prevenir cualquier choque eléctrico, heridas, fuego o explosiones.

- No utilice el equipo para otros fines que no sea la soldadura o reparación. El uso incorrecto puede causar fuego.
- El cable de red debe enchufarse en bases homologadas. Asegúrese de que está conectado a tierra correctamente antes de su uso. Al desenchufarlo, tire del conector, no del cable.
- No trabaje con tensión.
- La herramienta debe permanecer en el soporte cuando no está en uso con el fin de activar el modo de Sleep. El cartucho, la parte metálica de la herramienta y el soporte puede estar caliente incluso cuando la estación está apagada. Manipule con cuidado, incluso cuando ajuste la posición del soporte.
- No deje el aparato desatendido cuando esté en funcionamiento.
- No cubra las rejillas de ventilación. El calor puede causar que los productos inflamables se enciendan.
- Utilice un flux clasificado como “non residue” y evite el contacto con la piel y los ojos para evitar que se irriten.
- Tenga cuidado con el humo producido al trabajar.
- Mantenga su lugar de trabajo limpio y ordenado. Use gafas y guantes de protección adecuados. Así evitará cualquier daño.
- Tenga cuidado con los restos de estaño líquido. En contacto con la piel, puede causar quemaduras.
- Este aparato puede ser utilizado por personas a partir de 8 años y también por aquellas personas con movilidad reducida o capacidades físicas, sensoriales o mentales limitadas o con falta de experiencia y conocimientos siempre y cuando reciban supervisión o instrucciones relativas al uso del aparato de una manera segura y entiendan los riesgos que implica. Los niños no deben jugar con el aparato.
- Los niños no deberán realizar tareas de mantenimiento sin supervisión.

Especificaciones

CD-1SE 120V 50/60Hz. Fusible de entrada: 2A. Salida: 23,5V. Unidad de Control: **CD-1E**

CD-2SE 230V 50/60Hz. Fusible de entrada: 1A. Salida: 23,5V. Unidad de Control: **CD-2E**

CD-9SE 100V 50/60Hz. Fusible de entrada: 2A. Salida: 23,5V. Unidad de Control: **CD-9E**

- Peso: 2,7 Kg (5.9 lb)
- Dimensiones: 150 x 175 x 145 mm
- Potencia máxima CD-SE: 40W
- Rango de temperatura: 90-450 °C (190-840 °F) ($\pm 5\%$)
- Estabilidad de temperatura en reposo: ± 1.5 °C (± 3 °F)
- Resistencia punta a tierra: <2 ohms
- Tensión en punta: <2mV RMS
- Temperatura ambiente de trabajo: 10-40 °C / 50-104 °F
- Conector USB estación-PC

Cumple con las normativas CE.

Seguridad ESD

Präzisions Lötstation

Ref. CD-SE

Packliste

Die folgenden Artikel sollten enthalten sein:

CD Control Unit

CD Steuereinheit 1 Einheit
Ref. CD-1E (120V)
CD-2E (230V)
CD-9E (100V)



Precision Purpose Handle

Präzisions-Handstück 1 Einheit
Ref. T210-A



Power Cord

Netzkabel..... 1 Einheit
Ref. 0009417 (100V/120V)
0009401 (230V)



Cartridges

Kartuschen 2 Einheiten
Ref. C210001 (x1)
C210008 (x1)



Brass Wool

Messingwolle 1 Einheit
Ref. CL6210

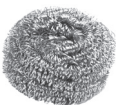

Sponge

Schwamm 1 Einheit
Ref. S0354



Handbuch 1 Einheit

Ref. 0016876

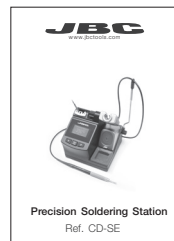

Merkmale

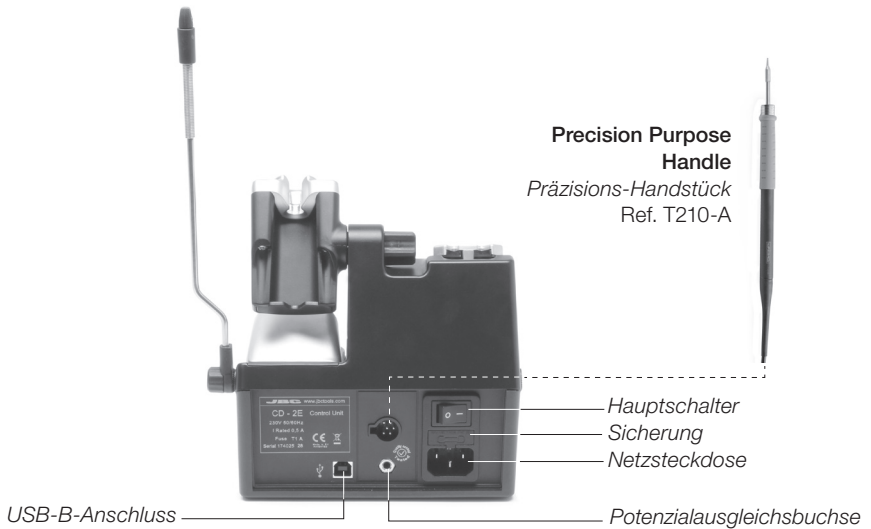

Verstellbare Ablage **Kabelausleger** (Ref. CC3702)

Stellen Sie die Werkzeugablage passend auf Ihre Arbeitsposition ein.

Fixieren Sie das Kabel am Aufleger und stellen ihn so ein, um Kabelsalat zu vermeiden.

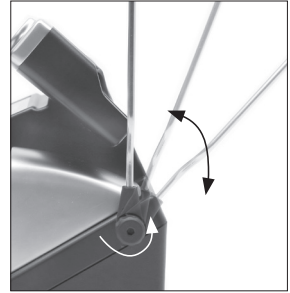
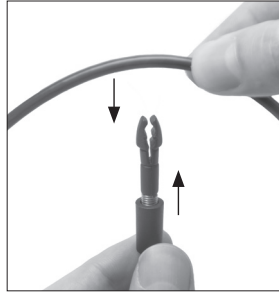
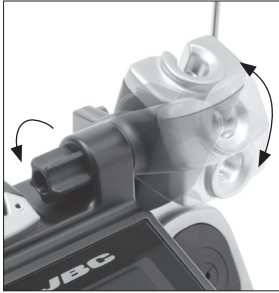

Spitzenreinigungssystem

Wählen Sie die Option aus, die am besten Ihre Reinigungsbedürfnisse erfüllt.

Splashguard

Spritzschutz

Ref. 0017576

Verhindert Lötmittelspritzer beim Einsatz von Messinggeflecht.

Antisplash Membrane

Schutzmembran

Ref. 0017574

Vermeidet Spritzer, um den Arbeitsbereich sauber zu halten.

Brass Wool

Messingwolle

Ref. CL6210

Sehr wirksame Reinigungsmethode. Lässt eine dünne Lotschicht auf der Spitze, wodurch die Oxidation zwischen Reinigung und Rückbenetzung vermieden wird.



Wiper Ref. CL0160

Spitzenabstreifer

Ein temperaturbeständiger Behälter ermöglicht es dem Werker, durch vorsichtiges Abklopfen oder Abstreifen überschüssiges Lot zu entfernen.

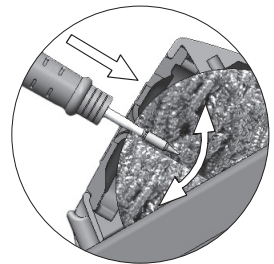

Falls die Spitze stark verschmutzt sein sollte, wird empfohlen, mit dem Spitzenabstreifer das überflüssige Zinn zu entfernen.

Wenn Sie den Spritzschutz entfernen müssen, befolgen Sie folgende Schritte:

1. Entriegeln Sie den Spritzschutz.



2. Nehmen Sie ihn heraus.

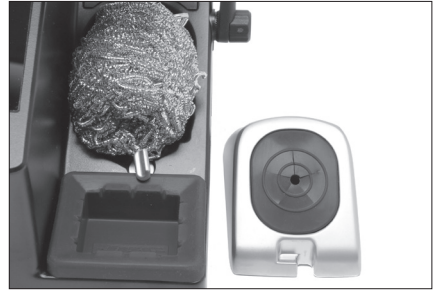

Weitere Optionen für den Spritzschutz (nicht im Lieferumfang enthalten):

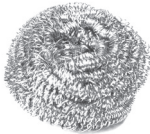

Inox Wool
Edelstahlwolle
Ref. CL6205
Sorgt für eine bessere
Reinigung an der Spitze.

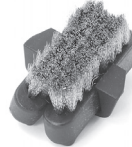

Metal Brush
Metallbürste
Ref. CL6220
Bei sorgfältiger
Benutzung sorgt sie
für eine gründlichere
Reinigung.

Spitzenabstreifer

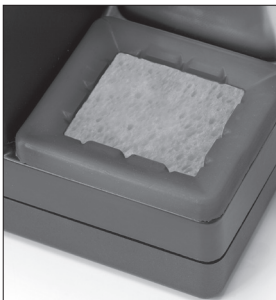

Sponge Schwamm
Ref. S0354
Die schonendste Reinigungs-
methode. Halten Sie den
Schwamm bei der Arbeit mit
destilliertem Wasser feucht, um
Spitzenverschleiß zu vermeiden.

Abklopfen:

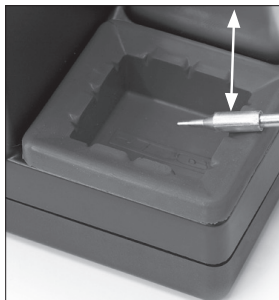

Klopfen Sie vorsichtig ab,
um überschüssiges Lot zu
entfernen.

Abstreifen:

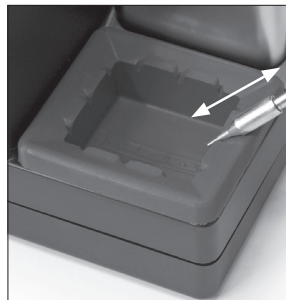

Benutzen Sie die
Ausparungen, um noch
vorhandene Partikel
abzustreifen.

Kompatible Handstücke

Für allgemeine Anwendungen

C245 Kartuschensortiment

General Purpose Handle

Universal-Handstück

Ref. T245-A



Blue Handle · Universal-Handstück, blauer Griff

Ref. T245-PA



Non-slip Handle · Universal-Handstück, rutschfester Griff

Ref. T245-B



Soft Thermal Insulator Handle · Schaumstoffgriff mit Wärmeisolierung

Ref. T245-C



Ersetzen Sie problemlos die T245-A-Griffe und T245-C-Griffe mit den Gleitstreifen (Ref. 0016057 Mit 4 Griffen ausgeliefert)

1. Streifen einschieben

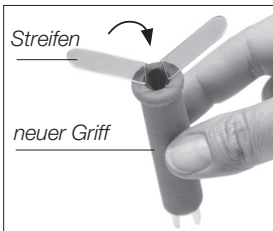

Stecken Sie die Gleitstreifen in den neuen Griff.

2. Handstück einführen

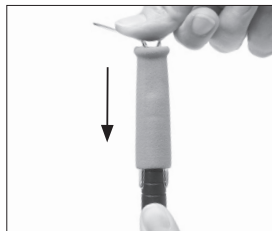

Schieben Sie den Griff mit den Streifen auf das Handstück.

3. Streifen herausziehen

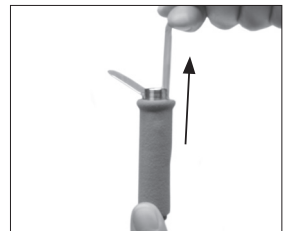

Um die Streifen zu entfernen, halten Sie den Griff fest und ziehen sie heraus.

Hinweis: Alle Modelle werden mit einem 1,5 m langen Kabel ausgeliefert

Für Präzisionsanwendungen

C210 Kartuschensortiment

Precision Purpose Handle · Präzisions-Handstück

Ref. T210-A



Blue Precision Handle · Präzisions-Handstück, blauer Griff

Ref. T210-PA



Dies ermöglicht Ihnen, das bei Lötarbeiten mit Bleilegerungen benutzte Handstück von dem bei bleifreien Aufträgen benutzten zu unterscheiden.

Für größere Nachfrage

Wichtig: Arbeiten Sie nur mit C245-Kartuschen, wenn sie an einer CD-Station benutzt werden. Handstücke für intensive Lötarbeiten, die ständig hohe Temperaturanforderungen stellen. Sie bieten eine größere Griffstärke und eine Schraube, die die Kartusche fixiert.

HD Purpose Handle

HD Handstück

Ref. T470-A



HD Purpose Handle + 3m cable

HD Handstück mit Kabel 3m

Ref. T470-SA

Tri-lobed HD Handle · Dreilappiges Handstück

Ref. T470-ZA

Für eine größere manuelle Werkzeugkontrolle.



Thermal Insulator HD Handle

Wärmeisoliertes HD Handstück

Ref. T470-FA

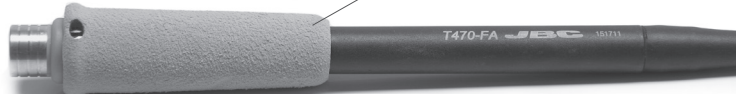

Thermal Insulator HD Handle + 3m cable

Wärmeisoliertes Handstück mit Kabel 3m

Ref. T470-MA

Geschäumte

Hinweis:

Alle Modelle werden mit einem 1,5 m langen Kabel ausgeliefert außer diejenigen, bei denen 3 m spezifiziert ist.

Spitzen-Schnellwechsler

Sparen Sie Zeit und wechseln Sie sicher Kartuschen, ohne die Station auszuschalten.

1. Entfernen

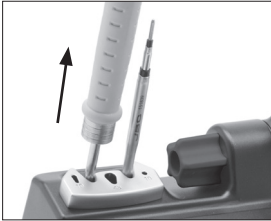

Handstück im Abzieher positionieren und Kartusche entfernen.

2. Einsetzen

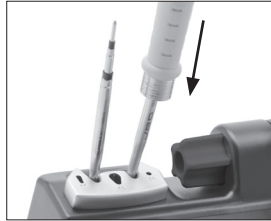

Handstück auf der neuen Kartusche positionieren, leichten Druck nach unten ausüben und Handstück aus dem Abzieher nehmen.

3. Fixieren

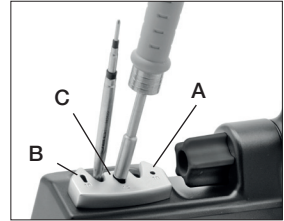

Drücken Sie die Kartusche* wie folgt in die Fixieröffnungen:
A. Für gerade C210.
B. Für abgeschrägte C210.
C. Für C245.

*Wichtig

Es ist wichtig, die Kartuschen für eine korrekte Verbindung genau bis zur Markierung einzustecken.

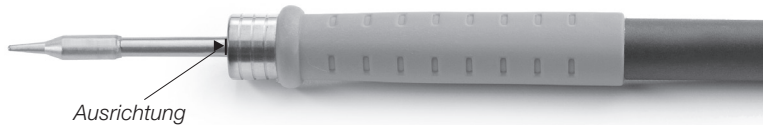

Kompatible Kartuschen

Die CD-Stationen können sowohl die C245- als auch die C210-Kartuschen nur mit dem passenden Handstück benutzen: T245/T470 oder T210. Finden Sie das passende Modell für Ihren Lötbedarf unter www.jbctools.com



Rund



Meißel



Rundgebogen



Abgeschrägt

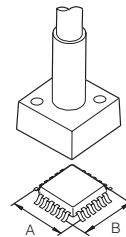

Spezialmodelle

USB-Anschluss

Laden Sie die neueste Software von unserer Website herunter, um Ihre Lötstation zu verbessern.

JBC Updater

www.jbctools.com/software.html

Aktualisieren Sie die Stations-Software über USB-Verbindung:



JBC Manager

www.jbctools.com/manager.html

Verwalten und überwachen Sie mit dem JBC Manager an einen PC angeschlossene Stationen:

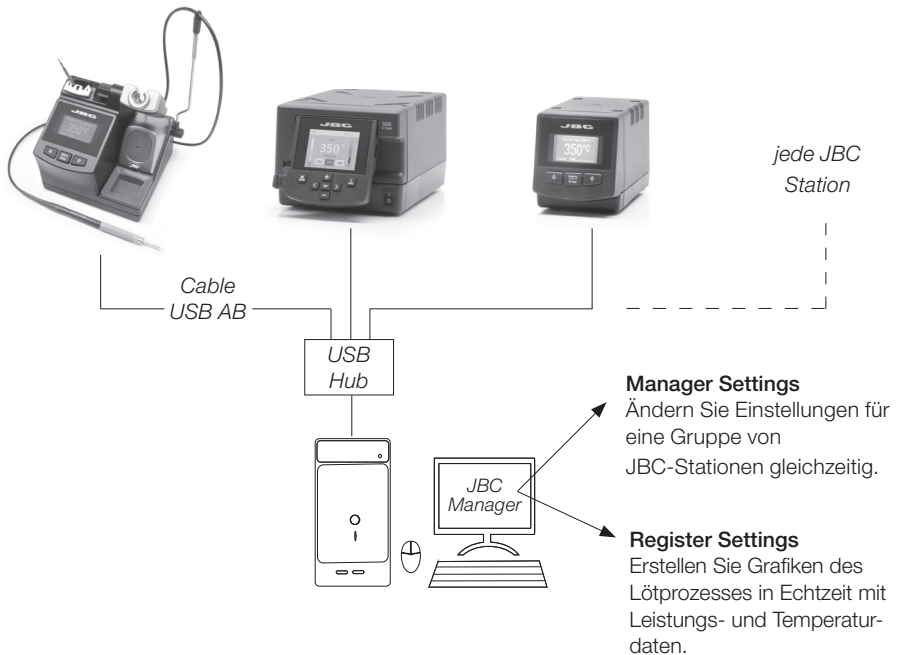

Betrieb

Das exklusive Heizsystem von JBC

Diese revolutionäre Technik ist dazu in der Lage, außerordentlich schnell die Spitzentemperatur zu erreichen. Dies ermöglicht es dem Benutzer, mit einer niedrigeren Temperatur zu arbeiten. Daraus ergibt sich eine fünfmal längere Spitzenzeit.

1. Arbeit



Nehmen Sie das Werkzeug aus der Ablage und die Werkzeugspitze wird auf die gewählte Temperatur aufgeheizt.

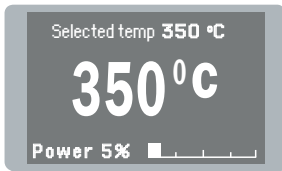

- Temperatur ändern (de 90 a 450°C)
- Temperaturstufen wählen
- Temperatur eingestellt

2. Sleep



Wenn sich das Werkzeug in der Ablage befindet, wird die Temperatur auf voreingestellte Sleep-Temperatur abgesenkt.



- Sleep-Temperatur ändern
- Sleepverzögerung einstellen (von 0 bis 9 Min oder kein Sleep)

3. Überwinterung

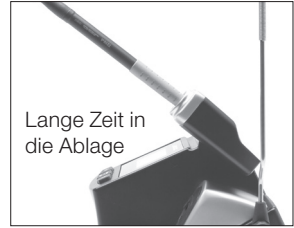

Nach längeren Zeiträumen der Untätigkeit wird die Stromversorgung abgeschaltet und das Werkzeug kühlt auf Raumtemperatur ab.



- Überwinterungsverzögerung ändern (von 0 bis 35 Min)

Prozess-Steuerung

Arbeitsbildschirm

Der Arbeitsbildschirm liefert in Echtzeit wertvolle Informationen über den Spitzenstatus.

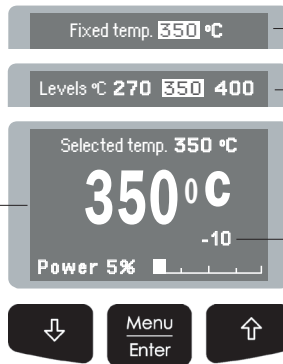

Zeigt eine spezifische Fixtemperatur an.

Angezeigt, wenn Sie Temperaturstufen ausgewählt haben.

“Temp. Anpass” Parameter. Sorgt für eine präzisere Anpassung zwischen der ausgewählten Temperatur und der derzeitigen.

Menübildschirm

Original-PIN: 0105

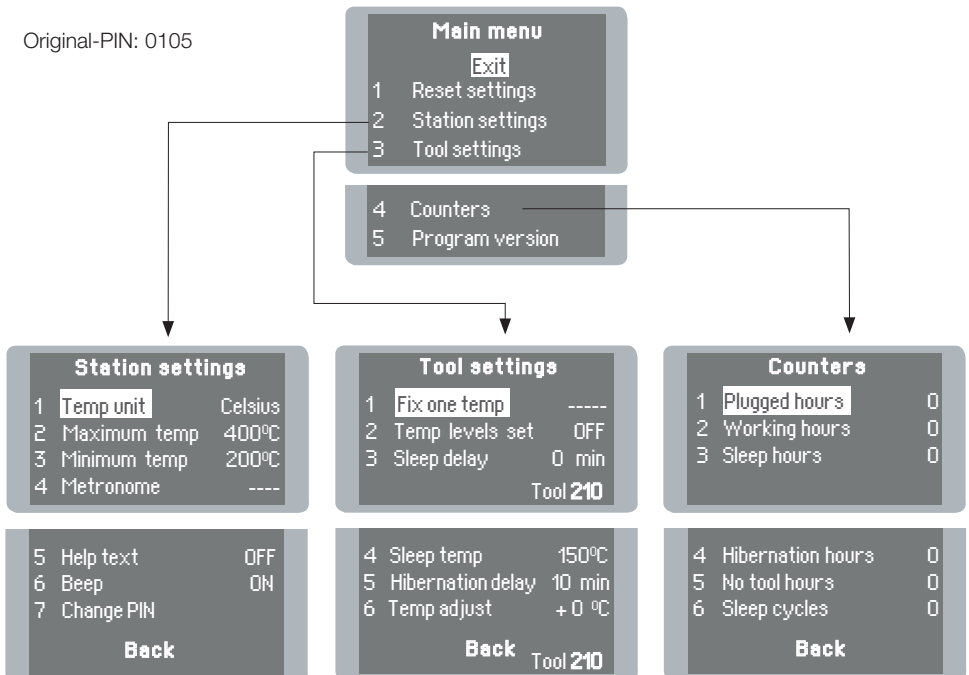

Parameter

Seien Sie bei der Benutzung dieser Parameter vorsichtig, da sie bei unsachgemäßer Anwendung die Standzeit der Spitze verkürzen können. Bitte beachten Sie die empfohlenen Richtlinien:

Stationseinstellungen

Parameterbeschreibung	Empfehlungen	Warnungen
Temperatureinheit Celsius (°C) oder Fahrenheit (°F)	unzutreffend	
Maximaltemperatur Legen Sie die Maximaltemperatur fest, mit der gearbeitet werden soll. Standard-Max.temp beträgt 400 °C (750 °F). Dies wird als ausreichend für die Arbeit mit den meisten bleifreien Anwendungen angesehen.	Der Temperaturbereich der Station liegt zwischen 90 - 450 °C (190-840 °F). Ändern Sie die Temperaturgrenzwerte, wenn Sie mit ungebräuchlicheren Anwendungen wie etwa unterem / oberem Schmelzpunkt (HMP) Löten oder Kunststoffen (z.B. riveting) arbeiten.	 In den meisten Fällen kann die Arbeit bei Temperaturen von über 400 °C (750 °F) die PCB und ihre Komponenten schädigen. Je kürzer die Zeiträume des Kontakts der Spitze mit der Lötstelle sind, umso weniger kann das Flussmittel korrekt arbeiten und ernsthaft die Spitzenstandzeit verkürzen. Wenn die Lötstelle höhere Leistungsansprüche stellt (z.B. Mehrschicht-Leiterplatten oder Platten mit hoher Wärmeabfuhr), empfiehlt JBC nachdrücklich andere Hilfsmittel wie Vorheizgeräte zu verwenden.
Minimaltemperatur Stellen Sie die Minimaltemperatur ein mit der gearbeitet werden soll. Standard Min.temp. beträgt 200 °C (392 °F). Diese wird als ein geeigneter Ausgangspunkt für mit Blei arbeitende Anwendungen angesehen.		
Metronom Dies aktiviert einen Piepton, der im Abstand von 1 bis 50 Sekunden wiederholt wird.	Nützlich für die Vorgabe einer Arbeitsgeschwindigkeit bei sich wiederholenden Arbeiten. Der Piepton lässt Sie den Zeitraum abschätzen, den die Spitze die Lötstelle berühren muss.	unzutreffend
Hilfetext Aktivieren Sie diesen Parameter, um vom System Info zu erhalten.	unzutreffend	unzutreffend
Piepton Aktivieren/deaktivieren des Pieptons des Tastenfelds.	unzutreffend	unzutreffend
PIN ändern Die Standard-Sicherheits-PIN-Nummer (0105) ändern.	Die PIN muss immer eingegeben werden, wenn ein Parameter geändert wird.	unzutreffend

Werkzeug-Einstellungen

Parameterbeschreibung	Empfehlungen	Warnungen
<p>Eine Temperatur festlegen Einen Wert innerhalb des Temperaturbereichs der Station festlegen (90-450 °C/190-840 °F).</p>	<p>Ideal zum Löten von mehreren Bauteilen mit einer bestimmten Temperatur. Die Station wird jeden Versuch der Temperaturänderung abweisen.</p>	<p>unzutreffend</p>
<p>Temperaturstufen eingestellt Ähnlich wie Parameter "Fix one temp". In diesem Fall kann der Nutzer bis zu 3 Werte für unterschiedlichen Leistungsbedarf einstellen.</p>	<p>Dies ermöglicht einen schnellen Wechsel zwischen 3 verschiedenen Temperaturen. Stellen Sie sie nach den zulässigen Werten für Ihre Lötanwendungen ein.</p>	<p>unzutreffend</p>
<p>Ruheverzögerung Stellt die Zeit ein, die das in der Ablage befindliche Werkzeug auf der eingestellten Temperatur bleiben wird, bevor es in Ruhezustand umschaltet. Die Spitzentemperatur wird dann auf die Ruhetemperatur.</p>	<p>Damit unsere Werkzeuge aus dem Standard-Ruhemodus in nur wenigen Sekunden die Arbeitstemperatur erreichen können, ist dieser Parameter auf 0 Min. voreingestellt. Sobald das Werkzeug wieder in die Ablage gestellt wird, wird die Temperatur automatisch auf die Ruhetemperatur abgesenkt, wodurch die Standzeit verlängert und Oxidation vermieden wird. Neuverzinnen der Spitze vor dem Abstellen des Werkzeugs in der Ablage wird die Abnutzung des Überzugs verhindern.</p>	<div style="background-color: #e0e0e0; padding: 10px;"> <p> Das Einstellen dieser Parameter auf höhere Werte, wird unnötig die Oxidation beschleunigen und die Spitzenstandzeit verkürzen vor allem wenn mit Temperaturen oberhalb von 450 °C (840 °F) gearbeitet wird.</p> </div>
<p>Ruhetemperatur Ist die eingestellte Temperatur, die die Spitze beim Abstellen des Werkzeugs in der Ablage erreicht.</p>	<p>Die Ruhetemperaturen sind so eingestellt, um einen Kompromiss zwischen Oxidationsvorbeugung und Bereitschaft zum Erreichen der Arbeitstemperatur in wenigen Sekunden herzustellen.</p>	

Werkzeug-Einstellungen

Parameterbeschreibung

Empfehlungen

Warnungen

Standbyverzögerung

Stellt die Zeit ein, die das Werkzeug die Ruhetemperatur hält, bevor es aus Standby schaltet.

Nach diesem Zeitraum wird die Stromversorgung abgeschaltet und die Spitze hält die Umgebungstemperatur.

Diese Funktion verhindert vollständig, dass die Spitze während langen Zeiträumen der Untätigkeit, in denen sich das Werkzeug in der Ablage befindet, rostet.

Erneutes Verzinnen der Spitze vor dem Abstellen des Werkzeugs in der Ablage hilft ebenso, die Spitzenverschleißung vor Rost zu schützen und die Spitzenstandzeit zu verlängern.

 Anheben des Werts wird die Oxidation beschleunigen und die Spitzenstandzeit verkürzen.

Temp Anpass

Sorgt für eine präzisere Anpassung zwischen der ausgewählten Temperatur und der derzeitigen.

Werte innerhalb ± 50 °C (± 90 °F) einstellen, um Nullfehler zu erreichen. JBC empfiehlt nachdrücklich die Benutzung von TID-A oder TIA-A-Thermometern, um präzise Ablesergebnisse zu erhalten.

 Wenn der Nutzer das Kartuschenmodell wechselt, sollte dieser Parameter auf 0 °C/F oder den von dieser Kartusche benötigten Wert zurückgesetzt werden. z.B. Wenn eine Korrektur von +20 °C (+36 °F) für C245966 (dickes Modell) eingestellt ist und dann der Nutzer die Kartusche durch eine C245030 (die dünner ist) ersetzt ohne zurückzusetzen, würde er mit einer 20 °C (+36 °F) niedrigeren Temperatur arbeiten, wenn C245030 keine Temperaturanpassung benötigt.

Wartung

Vor der Durchführung von Wartungsarbeiten oder Einlagerung die Geräte immer erst auskühlen lassen.

- Reinigen Sie den Bildschirm der Station mit einem Glasreiniger oder einem feuchten Lappen.
- Benutzen Sie einen feuchten Lappen, um das Gehäuse und das Werkzeug zu reinigen. Alkohol darf nur zur Reinigung der Metallteile benutzt werden.
- Regelmäßig überprüfen, dass die metallischen Teile des Werkzeugs/der Ablage sauber sind, damit die Station erkennen kann, wenn das Werkzeug in der Ablage steht.
- Halten Sie die Oberfläche der Spitze vor der Aufbewahrung sauber und verzinkt, um Spitzenoxidation zu vermeiden. Angerostete und verschmutzte Oberflächen mindern den Wärmedurchgang zur Lötstelle.
- Überprüfen Sie regelmäßig alle Kabel und Schlauchanschlüsse.
- Ersetzen Sie die Sicherung, wenn sie durchgebrannt ist, gemäß folgender Anweisungen:

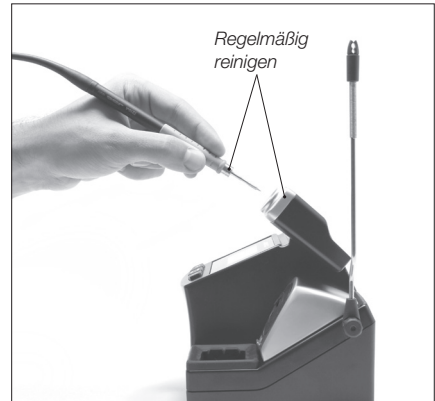

1. Entfernen Sie die Sicherung, indem Sie an der schwarzen Kappe ziehen. Falls notwendig, benutzen Sie ein Werkzeug, um sie herauszudrücken.

2. Drücken Sie die neue Sicherung in die Halterung und setzen Sie sie erneut in die Station ein.

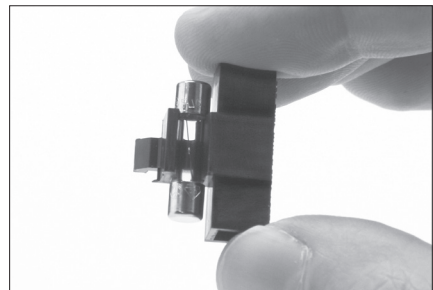

- Jedes defekte oder schadhafte Teil austauschen. Nur Original-Ersatzteile von JBC verwenden.
- Reparaturen dürfen nur von dem Vertragskundendienst von JBC durchgeführt werden.

Sicherheit



Die Sicherheits-Leitlinien müssen unbedingt eingehalten werden, um elektrischen Schlag, Verletzung, Feuer oder Explosion zu vermeiden.

- Die Anlage für keinen anderen Zweck verwenden als zum Löten oder Entlöten. Unsachgemäße Verwendung kann Feuer hervorrufen.
- Das Netzkabel muss in zugelassene Steckdosen eingesteckt werden. Vergewissern Sie sich vor der Benutzung, dass sie korrekt geerdet ist. Beim Herausziehen, am Stecker ziehen, nicht am Kabel.
- Nicht an aktiven Bauteilen arbeiten.
- Das Werkzeug sollte bei Nichtgebrauch in der Ablage abgestellt werden, um die Betriebsart Sleep auszulösen. Die Lötspitze, der metallische Teil des Werkzeugs und die Ablage können noch heiß sein, wenn die Station ausgeschaltet ist. Gehen Sie vorsichtig vor, sogar wenn Sie die Standposition justieren.
- Das eingeschaltete Gerät niemals unbeaufsichtigt lassen.
- Die Kühlungsgitter nicht abdecken. Hitze kann entzündliche Stoffe entzünden, sogar wenn sie sich außerhalb der Sichtweite befinden.
- Ein als "ohne Rückstände" eingestuftes Flussmittel verwenden und die Berührung mit Haut oder Augen vermeiden, um Reizung zu vermeiden.
- Sich vor dem beim Löten entstehenden Rauch in Acht nehmen.
- Ihren Arbeitsplatz sauber und aufgeräumt halten. Bei der Arbeit geeignete Schutzbrille und Handschuhe tragen, um gesundheitliche Schäden zu vermeiden.
- Im Umgang mit flüssigen Zinnrückständen muss äußerste Sorgfalt walten.
- Dieses Gerät kann von Kindern über acht Jahren und auch Personen mit körperlicher, sinnlicher oder geistiger Behinderung oder mangelnder Erfahrung benutzt werden, nachdem ihnen angemessene Überwachung oder Einweisung hinsichtlich der Verwendung des Geräts und der damit verbundenen Risiken gegeben worden ist. Kinder dürfen mit dem Gerät nicht spielen.
- Wartung darf nicht von Kindern durchgeführt werden, wenn sie hierbei nicht beaufsichtigt werden.

Technische Daten

CD-1SE 120V 50/60Hz. Eingangssicherung: 2A. Ausgang: 23,5V. Steuereinheit Modell: **CD-1E**

CD-2SE 230V 50/60Hz. Eingangssicherung: 1A. Ausgang: 23,5V. Steuereinheit Modell: **CD-2E**

CD-9SE 100V 50/60Hz. Eingangssicherung: 2A. Ausgang: 23,5V. Steuereinheit Modell: **CD-9E**

- Gesamtgewicht des Geräts: 2.7 Kg (5.9 lb)
- Abmessungen: 150 x 175 x 145 mm
- Spitzenausgangsleistung: CD-SE: 40W
- Temperatúrauswahl: 90-450 °C (190-840 °F) (±5%)
- Idle Temp. Stabilität (noch Luft): ±1.5 °C (±3 °F)
- Spitze-Erde-Widerstand: <2 ohms
- Spitze-Erde-Spannung: <2mV RMS
- Umgebungstemperatur: 10-40 °C / 50-104 °F
- USB-Anschluss Station-PC

Erfüllt EG-Normen

ESD-gerechtes Gehäuse "skin effect"

产品描述

需包含以下部件：

CD 控制主机 1 件
Ref. CD-1E (120V)
CD-2E (230V)
CD-9E (100V)



精确用途手柄 1 件
Ref. T210-A



电源线 1 件
Ref. 0009417 (100V/120V)
0009401 (230V)



烙铁头 2 件
Ref. C210001 (x1)
C210008 (x1)



铜丝球 1 件
Ref. CL6210

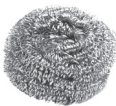

海绵 1 件
Ref. S0354



说明书 1 件
Ref. 0016876

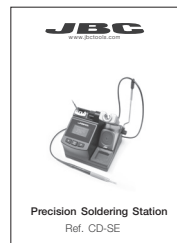

产品特性

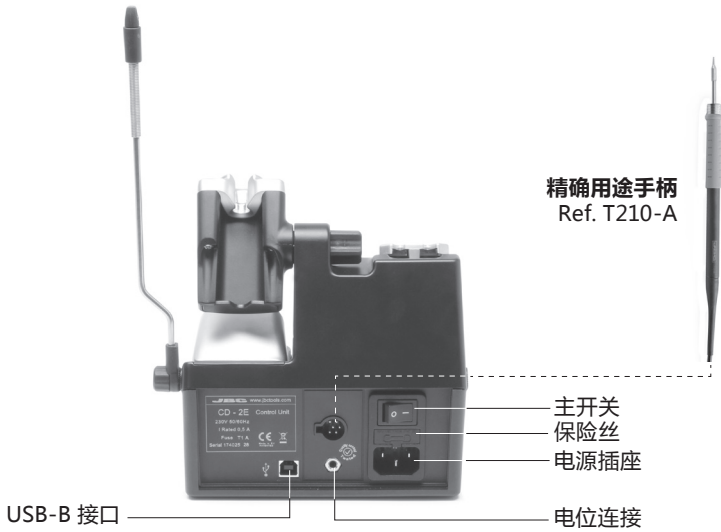

可调式支架

调节工具支架，满足工作位置需求。

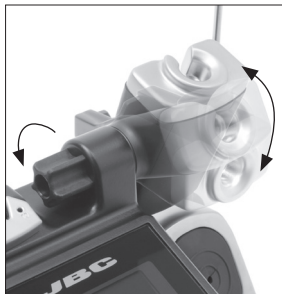

集线器 (Ref. CC3702)

将电线放置在集线器上，避免工作位置受到电线干扰。

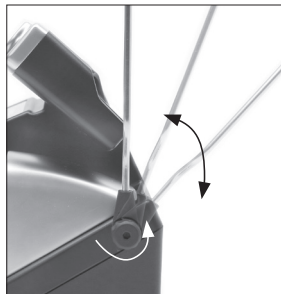
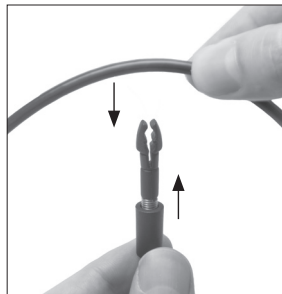

焊嘴清洁系统

选择最适合您的焊接清洁需求的选择。

防溅罩

Ref. 0017576

可防止在使用铜丝清洁球的时候残锡的飞溅。

防溅层

Ref. 0017574

防止溅锡确保工作环境的整洁。

铜丝球

Ref. CL6210

有效清洁方法。在清洁后到下次焊接前对焊嘴加锡保养，以防焊嘴氧化。

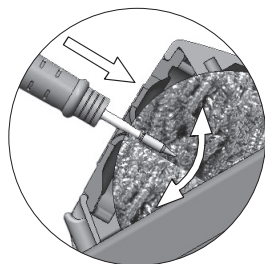

如果烙铁头非常脏，建议先刮掉多余的锡。

擦板

Ref. CL0160

耐高温凹槽可以让操作者通过轻轻拍打或擦拭去除多余的焊锡。

如果需要拆下保护罩，请按照以下步骤进行：

1. 松开保护罩扣锁。



2. 撤走保护罩。



其他防溅罩选项 (不包括)：

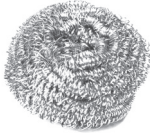

不锈钢丝球
Ref. CL6205
为焊嘴提供更深层的
清洁

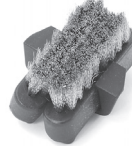

金属刷
Ref. CL6220
如果使用得当，
可提供更彻底的清洁。

擦板

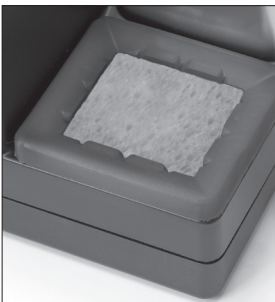

海绵
Ref. S0354
最温和的清洁方法。
工作时用蒸馏水润湿海绵避免
焊嘴磨损。

敲击

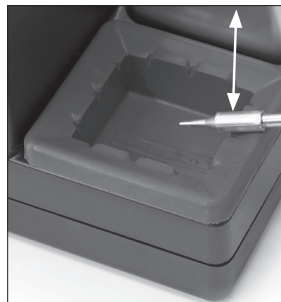

轻轻敲击除去多余的残锡。

擦拭

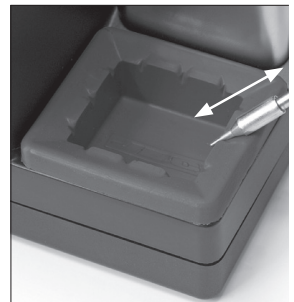

使用槽口擦拭任何残留的锡粒。

兼容手柄

普通用途

与 C245 烙铁头系列兼容

普通用途手柄

Ref. T245-A



蓝色普通用途手柄

Ref. T245-PA

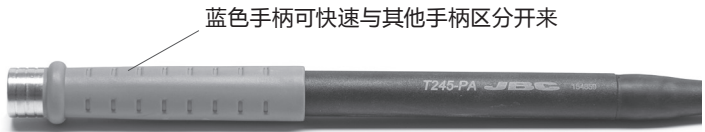

防滑手柄

Ref. T245-B



柔软握柄隔热型

Ref. T245-C



使用滑动标签可轻松更换T245-A / T245-C握套 (型号 0016057 共四个握套)。

1. 插入标签

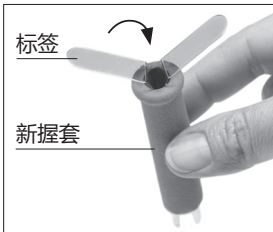

将滑动标签插入新握套内。

2. 套上手柄

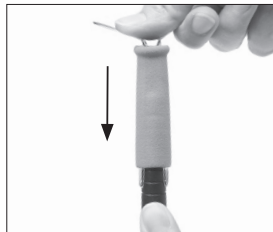

顺着标签将握套套上手柄。

3. 移去标签

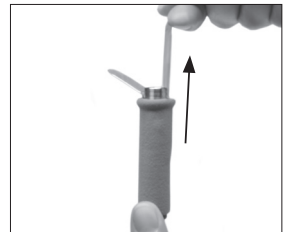

要移去标签，握住手柄并向外拉。

注意:所有型号都配有1.5米电线。

用于精确操作

与 C210 烙铁头系列兼容

精确用途手柄

Ref.T210-A



蓝色精确手柄

Ref.T210-PA



蓝色手柄可快速与其他手柄区分开来

更高要求

重要:仅与 C245 焊头兼容于 CD 台。

高精度焊接工作需要持续的高导热。它们提供良好的隔热条件，其中还有一个螺丝固定住烙铁头以防止打滑。

普通用途HD手柄

Ref.T470-A



普通用途HD手柄，带3米电线

Ref.T470-SA

三叶型手柄

Ref.T470-ZA

更好地握持工具。



隔热HD手柄

Ref.T470-FA



隔热HD手柄，带3米电线

Ref.T470-MA

海绵

注意:所有型号都配有1.5米电线，配有3米电线的型号除外。

快速烙铁头更换器

节省时间,安全更换烙铁头,主机无需断电。

1. 移除

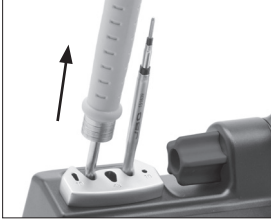

将手柄放置在插拔座上,拔出烙铁头。

2. 插入

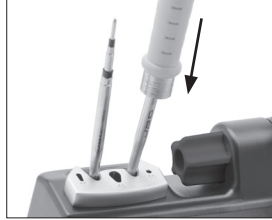

将手柄置在新烙铁头顶端,轻轻下压。

3. 固定

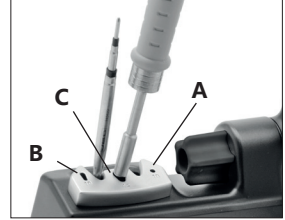

使用孔洞来固定烙铁头*,操作如下:

A. 直线型烙铁头 C210.

B. 弯曲型烙铁头 C210.

C. C245.

*重要

切记尽量将烙铁头插入到标识处,以确保正确的连接。

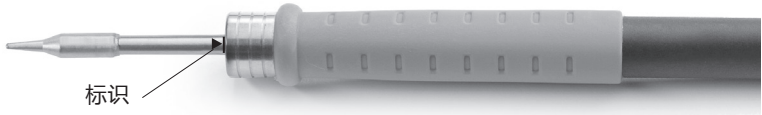

兼容烙铁头

CD 主机 使用C245 烙铁头及 T245/T470 手柄或 C210 烙铁头及 T210 手柄。找到最适合你的焊接需求的款式,请登录 www.jbctools.com

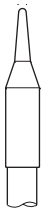

圆头



凿形



圆形弯曲



斜角

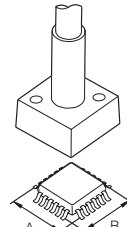

特殊型号

USB 接口

自我们官网下载最新软件, 确保您的焊台处于最佳状态。

JBC 更新程序 (JBC Updater)

www.jbctools.com/software.html

通过USB接口更新软件。

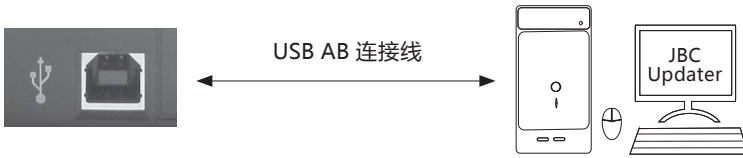

JBC 管理员 (JBC Manager)

www.jbctools.com/manager.html

通过该程序使用电脑管理和跟踪多台焊台。可将数据导出到其他电脑上。

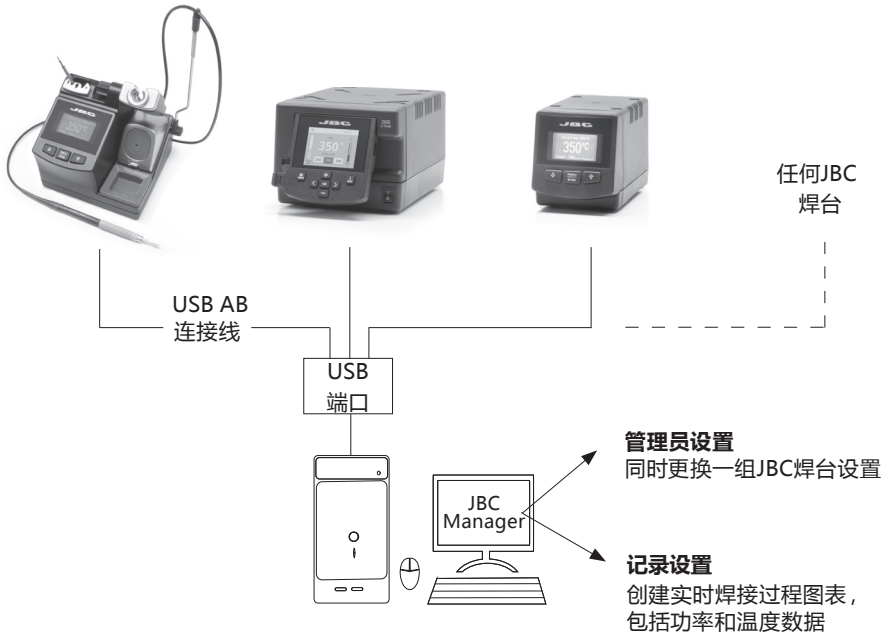

操作

JBC 专属加热系统

革命性技术,可以令烙铁头温度快速回升。
这意味着用户可以在较低温度下操作,并提高焊接质量。
之后,烙铁头温度在睡眠和休眠模式下降低,可令其寿命延长五倍。

1. 工作



当工具从支架下取下时,烙铁头温度会加热到选定温度。

2. 睡眠 (Sleep)



当工具放置在支架上时,温度会下降到预置睡眠温度。

3. 休眠 (Hibernation)



长时间放置
在支架上

长时间没有使用后,电源会切断,工具会冷却到室温。

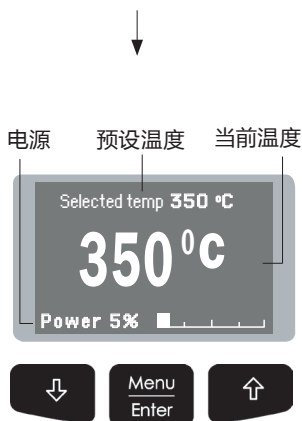

- 更改温度 (自 90 至 450°C)
- 选择温度等级
- 固定一个温度



- 设置睡眠温度
- 设置睡眠延迟 (从 0 到 9 分钟或永不睡眠)



- 设置休眠延迟 (从 0 到 35 分钟或永不休眠)

流程控制

工作屏

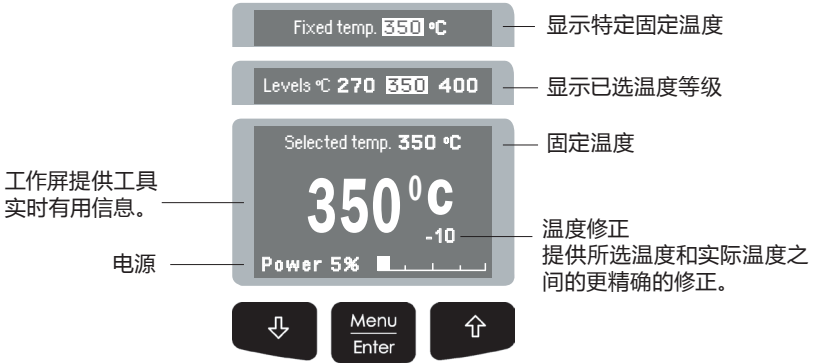

菜单屏

原始密码: 0105

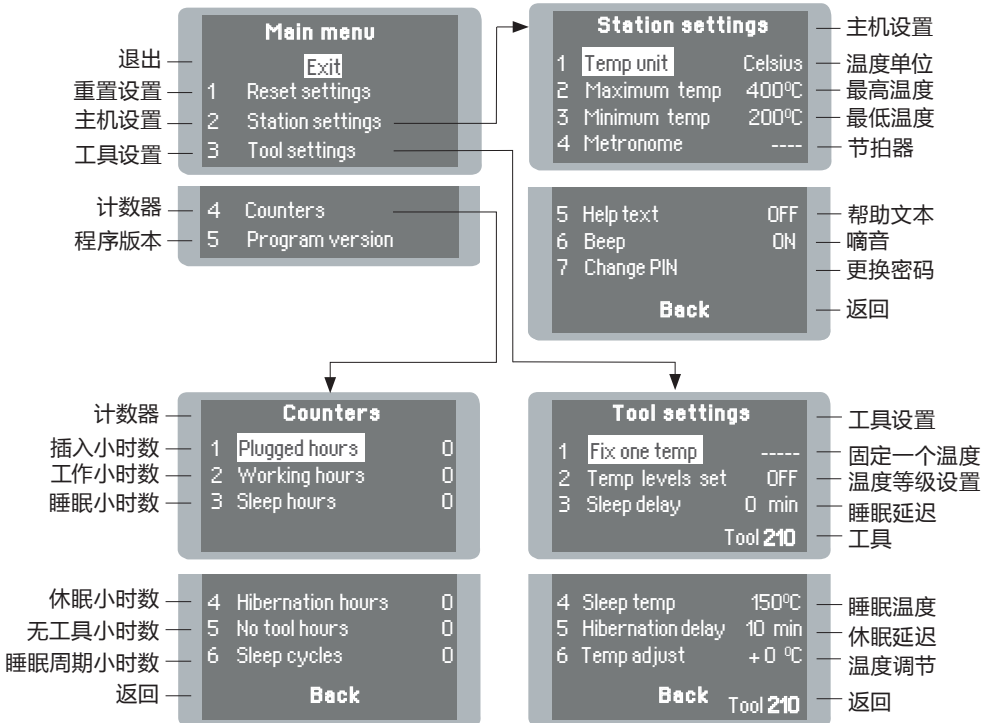

参数

请注意如果这些参数使用不当可能会导致焊嘴寿命的减少。请遵循推荐的准则：

主机设置

参数描述	建议	警告
温度单位 摄氏度 (°C)或者华氏度(°F)	不适用	
最高温度 设定进行工作的最高温度。 默认的最高温度为400°C (750°F)。对于大多数无铅应用来说这已被视为足够高温。	主机的温度范围在90-450°C (190-840°F)。更改温度限制用于不常见的应用,如低/高熔点锡焊 (HMP) 或者塑料应用 (比如铆合)。	 在大多数情况下,工作温度超过 400°C (750°F) 会损坏电路板及其组件。甚至于焊嘴与焊点更短时间的接触,使助焊剂无法发挥正常功效,严重降低烙铁头寿命。如果焊点需要更大功率 (比如多层板或者高散热板), JBC强烈推荐配合使用其他辅助产品如预热台。
最低温度 设定进行工作的最低温度。 默认的最低温度为200°C (392°F)。对于有铅应用来说这被视为适当的起始温度。		
节奏提示 在每1-50秒重复的一种蜂鸣声。	可用来设定在重复作业时的工作速率。蜂鸣声提醒您必须开始焊接的时间段。	不适用
帮助文本 激活此参数可以从系统中获得的信息。	不适用	不适用
提示音 开启/禁用按键的提示音。	不适用	不适用
修改个人密码 修改默认的安全密码 (0105)。	每次更改参数必须输入个人密码。	不适用

工具设置

参数描述	建议	警告
<p>固定一个温度 固定一个温度值范围在 (90-450°C/190-840°F)。</p>	<p>非常适合需要在特定温度下焊接多个组件。主机将拒绝任何更改温度的意图。</p>	<p>不适用</p>
<p>温度等级设置 类似于“固定一个温度”的参数。在这种情况下,用户可以根据不同的功率要求设置最多3个温度值。</p>	<p>这允许在3个不同温度之间快速切换。根据您的焊接应用允许的温度值来设置。</p>	<p>不适用</p>
<p>睡眠延时 设置工具在置放架上起并保持所选温度到进入睡眠模式的时间。焊嘴温度随即降到睡眠温度 (默认150°C/302°F 或者 260°C/500°F 只适用于拆焊)。</p>	<p>因为我们的工具可以仅在2秒内从默认睡眠模式升到工作温度,此参数预设为0分钟。一旦工具被回放到置放架上,温度将自动降到睡眠温度,延长焊嘴寿命并防止氧化。工具在放置到置放架上之前做加锡保养可防止涂层的磨损。</p>	<p> 没必要将这些参数设置过高,会导致焊嘴加速氧化并缩短焊嘴寿命,特别是在450°C (840°F)的温度下作业。</p>
<p>睡眠温度 当工具在置放架时,焊嘴将达到到的设定温度。</p>	<p>在防氧化和几秒内快捷升温到工作温度,睡眠温度的设置实现了两者之间的一种折中方案。</p>	

焊嘴设置

参数描述

休眠延时
设置工具从睡眠温度进入休眠模式的时间。默认设置为10分钟。这段时间之后，电源被切断，焊嘴温度降至室温。

建议

此功能完全防止工具在置放架上长时间不使用而产生的氧化。
放置到置放架之前对工具做加锡保养也有助于保护涂层，防止焊嘴氧化，延长焊嘴寿命。

警告

 增大默认值将加速焊嘴的氧化和缩短其使用寿命。

温度修正

提供所选温度和实际温度之间的更精确的修正。

设置数值在 $\pm 50^{\circ}\text{C}$ ($\pm 90^{\circ}\text{F}$) 以实现零失误。JBC强烈推荐
使用TID-A或TIA-A测温仪以获得精确的读数。

 当用户更换烙铁头类型，此参数须重设至 $0^{\circ}\text{C}/\text{F}$ 或者适合该烙铁头的温度值。比如，为C245966 (粗类型) 设置的修正值为 $+20^{\circ}\text{C}$ ($+36^{\circ}\text{F}$)，之后用户更换到C245030 (较细类型) 而没有重设修正值，在C245030不需要调整温度的情况下，用户实际上在低 20°C ($+36^{\circ}\text{F}$) 的温度下作业。

维护

在维护或储存之前需确保设备已经冷却。

- 用玻璃清洁剂或抹布清洁主机屏幕。
使用抹布清洁外壳和工具。
酒精只可用来清洁金属部件。
- 定期检查工具金属件及支架, 确保清洁, 确保主机可以保持探测到工具状态。
- 储存前, 保持烙铁头清洁并加锡保养以防氧化。
生锈或肮脏的表面会减少传递到焊点的热量。
- 定期检查电线和管子。
- 按如下图示更换熔断保险丝:



1. 推动黑色盖子取下保险丝。如有必要可使用工具。

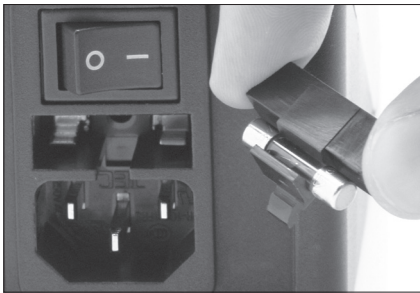

2. 将新的保险丝放入保险丝盒, 并将其放入工作台。

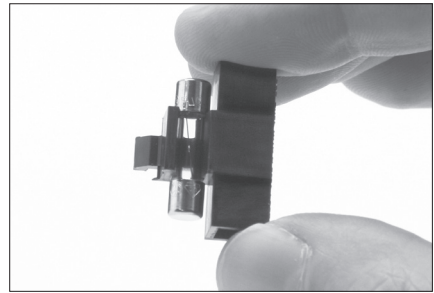

- 更换任何受损的元件。仅使用JBC原装配件。
- 修理必须由JBC专业技术服务人员进行。

安全



必须遵守安全准则，以防止电击，人身伤害，火灾或爆炸。

- 不要使用本产品用于焊接或返修以外的任何目的。不正确使用可能造成火灾。
- 电源线必须插入核准的电源。确保使用前妥善接地。拔掉电源时握住插头，而不是电线。
- 请勿在带电部件上操作。
- 该工具在不使用时应放置在支架上，以激活休眠模式。
烙铁头，金属部分和支架即使在焊台被切断电源时仍旧是热的。
小心轻放，包括调整支架位置时。
- 设备开着时，切勿无人看管。
- 请勿覆盖通风口。热量可引起易燃物品引燃。
- 使用“无残渣”类锡丝，避免与皮肤或眼睛接触，以防刺激。
- 小心焊接时产生的烟雾。
- 保持工作场所干净整洁。操作时，为避免造成人身伤害，请穿戴适当的防护眼镜和手套。
- 残锡液易引起灼伤，请小心处理。
- 本产品允许八岁以上儿童，肢体，感官或心智有残缺的人士，以及缺乏经验的人士使用，
但必须提供必要的监护及指导，并且了解本产品可能涉及的危险。切勿让儿童把玩。
- 没有监管，儿童不得对本产品进行维护。

技术规格

CD-1SE 120V 50/60Hz. 输入保险丝: 2A. 输出: 23,5V. 主机款式: **CD-1E**

CD-2SE 230V 50/60Hz. 输入保险丝: 1A. 输出: 23,5V. 主机款式: **CD-2E**

CD-9SE 100V 50/60Hz. 输入保险丝: 2A. 输出: 23,5V. 主机款式: **CD-9E**

- 重量: 2.7 Kg (5.9 lb)
- 尺寸: 150 x 175 x 145 mm
- 最高输出功率 CD-SE: 40W
- 温度范围: 90-450°C (190°-840°F) (±5%)
- 空置温度稳定性 (静止空气): ±1.5 °C / ±3 °F
- 焊接接地电阻: <2 ohms
- 焊接接地电压: <2mV RMS
- 工作室温: 10-40 °C / 50-104 °F
- USB 连接焊台-PC

符合CE标准

防静电“趋肤效应”保护外壳

Exploded View · Despiece · Explosionszeichnung · 分解圖

CD-1SE 120V
CD-2SE 230V
CD-9SE 100V

PRECISION SOLDERING STATION

FROM SERIE 186802

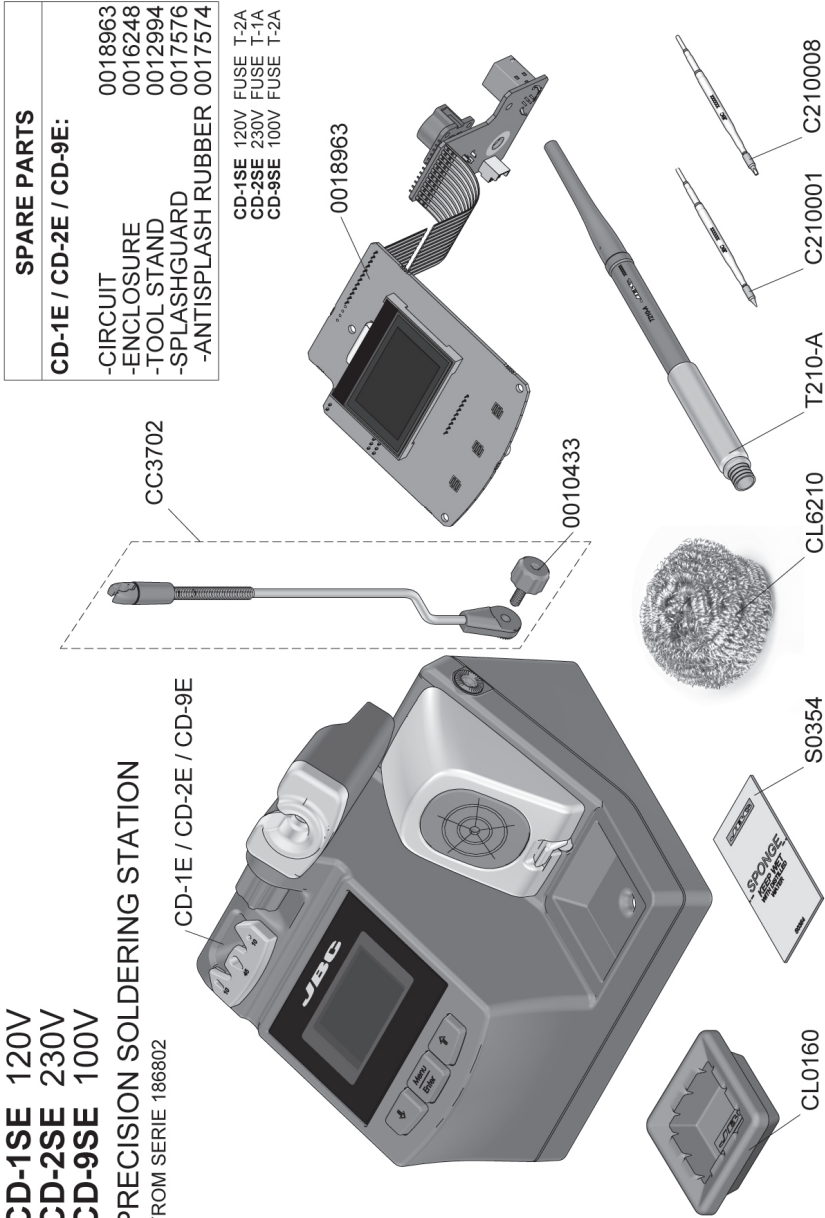

SPARE PARTS

CD-1E / CD-2E / CD-9E:

- CIRCUIT 0018963
- ENCLOSURE 0016248
- TOOL STAND 0012994
- SPLASHGUARD 0017576
- ANTISPLASH RUBBER 0017574

- CD-1SE 120V FUSE T-2A
- CD-2SE 230V FUSE T-1A
- CD-9SE 100V FUSE T-2A

Warranty

JBC's 2 year warranty covers this equipment against all manufacturing defects, including the replacement of defective parts and labour.

Warranty does not cover product wear or misuse.

In order for the warranty to be valid, equipment must be returned, postage paid, to the dealer where it was purchased.

保修

JBC的2年保修涵盖了该设备所有的制造缺陷，

包括更换损坏的零件和人工。

保修不包括因使用或误用而产生的产品损坏。

为了使保修有效，

设备邮资已付返回到购买时的经销处返修。

Garantía

Esta garantía de 2 años cubre este equipo contra cualquier defecto de fabricación, incluyendo la sustitución de partes defectuosas y mano de obra.

La garantía no cubre el desgaste del producto por uso o mal uso.

Para que esta garantía sea válida, el equipo debe ser devuelto, a portes pagados, al distribuidor donde se compró.

Garantie

Die 2-Jahres-Garantie von JBC erstreckt sich auf das Gerät bei Herstellungsfehlern, einschließlich Fehlern der Verarbeitung und dem Ersatz defekter Teile und deren Austausch.

Die Garantie gilt nicht für Produktverschleiß durch normale Nutzung oder durch falsche Anwendung.

Damit die Garantie Gültigkeit erlangt, muß das Gerät an den Händler, bei dem es gekauft wurde, zurückgesand weden (Porto bezahlt).



This product should not be thrown in the garbage.

In accordance with the European directive 2012/19/EU, electronic equipment at the end of their life must be collected and returned to an authorized recycling facility.

Este producto no debe desecharse en la basura.

De acuerdo a la directiva europea 2012/19/UE, los equipos electrónicos al final de su vida se deberán recoger y trasladar a una planta de reciclaje autorizada.

Dieses Produkt sollte nicht mit dem Hausmüll entsorgt werden.

In Übereinstimmung mit der europäischen Richtlinie 2012/19/EU müssen elektronische Geräte am Ende ihrer Lebensdauer eingesammelt und einem autorisierten Recyclingbetrieb zugeführt werden.

本产品不应被扔在垃圾筒内。

根据欧洲指令2012/19/EU，电子设备在其寿命结束后必须被收集并返回到授权回收工厂。