

# JBC

[www.jbctools.com](http://www.jbctools.com)



**Hot Air Station  
without Extractor desk**

Ref. JTSE-QA

# Packing List

The following items should be included:

**JTSE Control Unit** .....1 unit  
 Ref. JTSE-1A (100V / 120V)  
 JTSE-2A (230V)



**Stand** .....1 unit  
 Ref. JT-SD



**Heater hose set** .....1 unit  
 Ref. JT-T1A (100V / 120V)  
 JT-T2A (230V)



**Thermocouple type K** .....1 unit  
 Ref. PH218



**Nozzles** ..... 1 unit  
 Ref. JN2015  
 JN2012  
 JN2020



**Power cable** .....1 unit  
 Ref. 0009417 (100V / 120V)  
 0009401 (230V)



**Manual** .....1 unit  
 Ref. 0018814



## Features

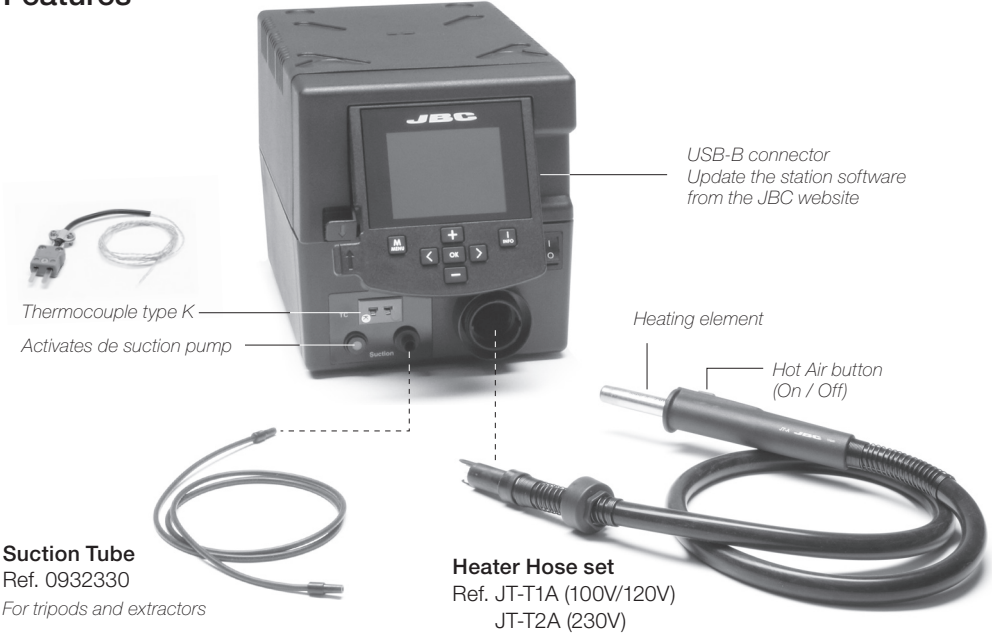

**Suction Tube**  
Ref. 0932330  
For tripods and extractors

**Heater Hose set**  
Ref. JT-T1A (100V/120V)  
JT-T2A (230V)

**Stand**  
Ref. JT-SD

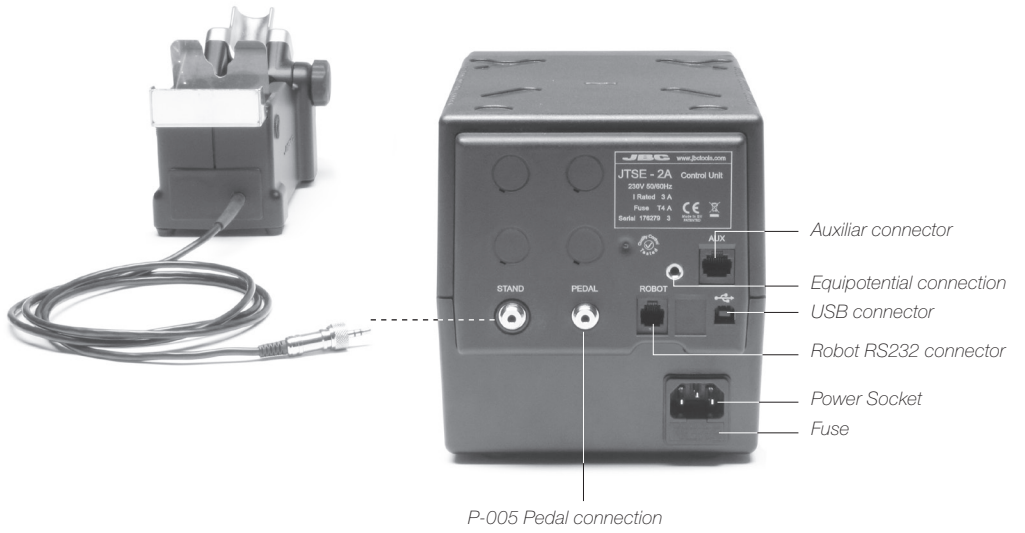

# Adjustable Stand

Adjust the tool holder angle to suit your work position.

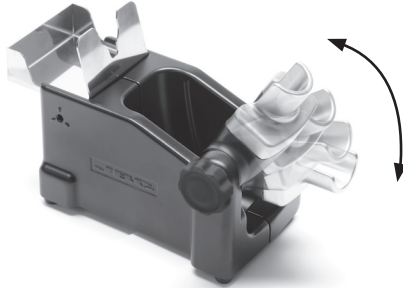

## Operation Modes

1. From the Tool Settings Menu, select the mode to activate the tool depending on the task.

### Tool button

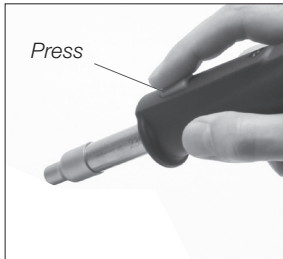

Press the start/stop button to blow hot air.

### Autostart



The tool automatically starts blowing hot air when lifted from the stand.

### Pedal\*

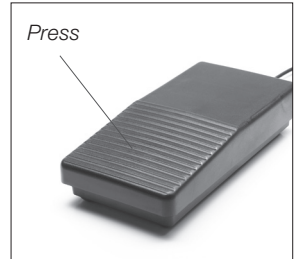

Press the Pedal to blow hot air and release to stop.

\*The **P-005** Pedal is not supplied with this station. See our website.

2. The tool stops blowing when pressing the start/stop button. If the stand is connected to the station and for safety it will also stop when returned to the stand.



## Quick Nozzle Changer

Changing nozzles quickly and safely.

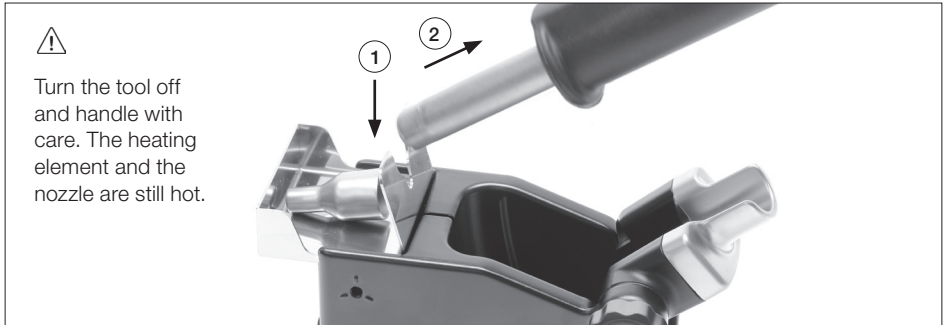

### Compatible Nozzles

The JT-TA works with JT nozzles. Find the model that best suits your soldering needs in [www.jbctools.com](http://www.jbctools.com)

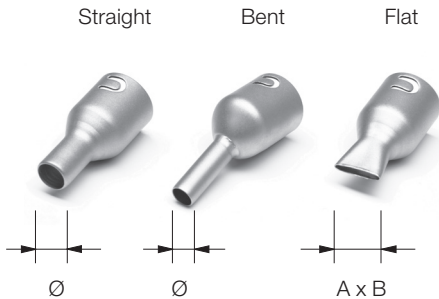

* Ref.	Shape	Ø Size (mm)	Ø Size (in)
JN2020	Straight	Ø 8	Ø 0.31
JN8417	Straight	Ø 10	Ø 0.4
* JN2015	Bent	Ø 4	Ø 0.16
* JN2012	Bent	Ø 6	Ø 0.24
JN6633	Bent	Ø 8	Ø 0.31
JN7637	Flat	10 x 2	0.4 x 0.08
JN7638	Flat	20 x 2	0.8 x 0.08
JN7639	Flat	30 x 2	1.18 x 0.08

\* Included

In case of a loosely fitting nozzle:

1. Push the nozzle tab inwards with a screwdriver or flat-nosed pliers.

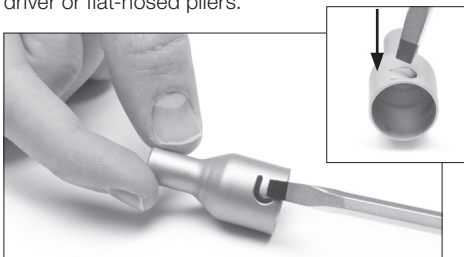

2. Insert the nozzle into the JT-TA again.

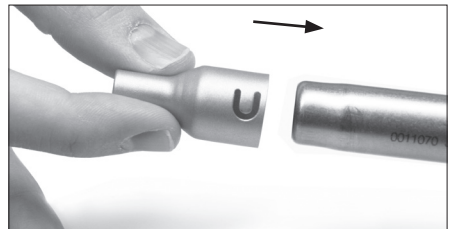

# Operation

## 1. Placing

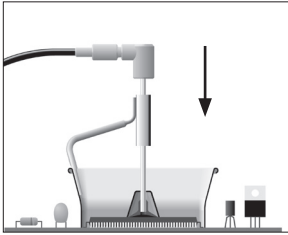

Position the extractor with the appropriate suction cup and press the suction button.

## 2. Heating

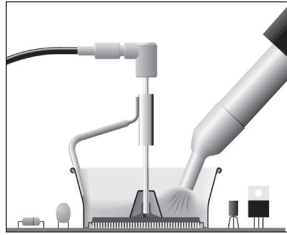

Heat the component.

## 3. Extracting

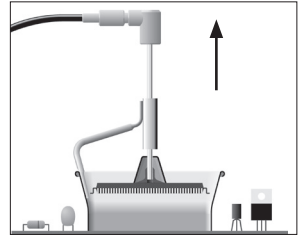

The component lifts off automatically when the solder melts.

# Using the Thermocouple type K

Connect a TC type K (PH218) to the station and use it as a protection or regulation sensor. You can define its use mode by means of the “Ext TC mode” option in the “Tool” menu.

You can choose from **two work modes**:

**Regulation:** the station regulates the air temperature automatically to maintain the External Thermocouple (TC) temperature.

**Protection:** the station cuts the air supply off when the External Thermocouple (TC) temperature is reached.

*Fix the TC with Kapton Tape (Ref. PH217) as near as possible to the component being worked on. If Kapton tape is not ESD you must use an ionizer.*

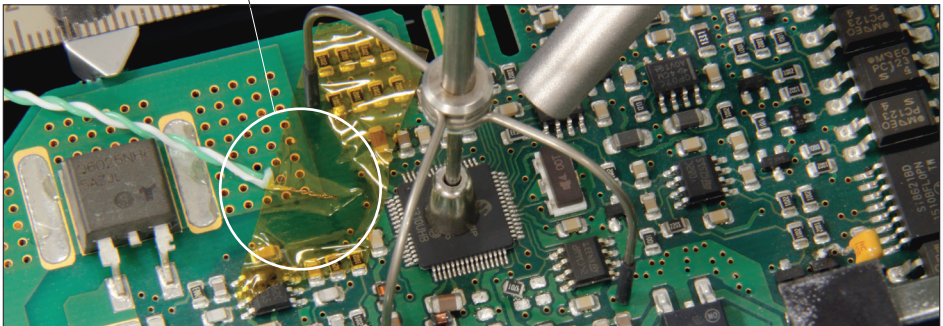

IPC\* does not recommend exceeding ramp-up rates over 3 - 4 °C / sec (5 - 7 °F / sec) so as to reduce the risk of thermal stress on the PCB.

\* IPC was founded in the U.S. in 1957 as the Institute for Printed Circuits.

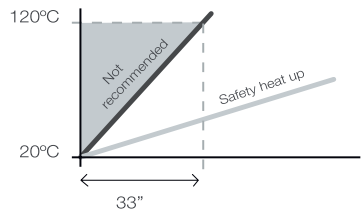

## Process Control

The JTSE offers an **intuitive user interface** which provides **quick access** to station parameters.  
**Original PIN: 0105**

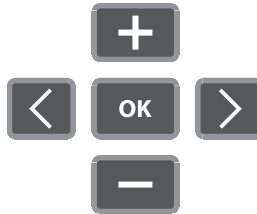
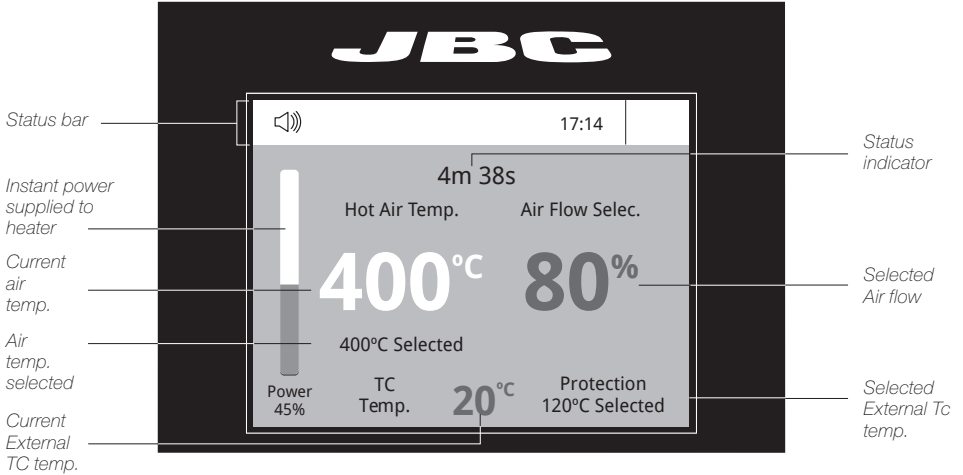

Station Information

### Menu Options

Press INFO for each parameter description.



Station

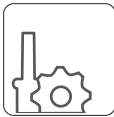

Tools



Profiles

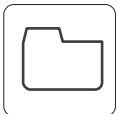

Files



Graphics



Reset

### System notifications (Status Bar)

- USB flash drive is connected.
- Station is controlled by a PC.
- Station is controlled by a robot.
- Station software update.  
Press INFO to start the process.
- Warning.  
Press INFO for failure description.
- Error. Press INFO for failure description, the type of error and how to proceed.

# Profiles



Profiles

In this mode you can **set up or edit** as many as 25 profiles of temperature and air flow.

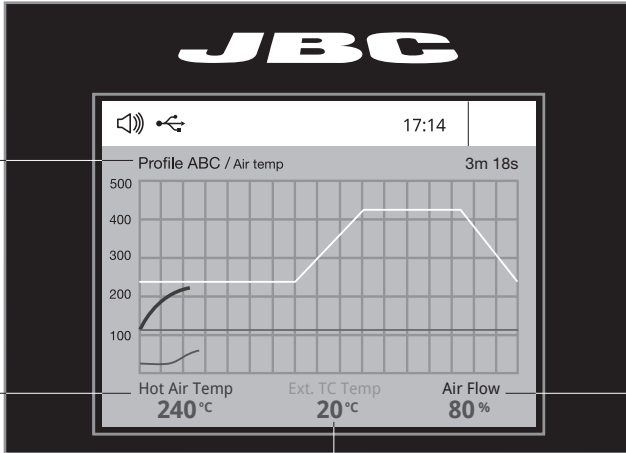

Profile name

Current air temp.

Current air flow

Current External TC temp.

# Edit Mode

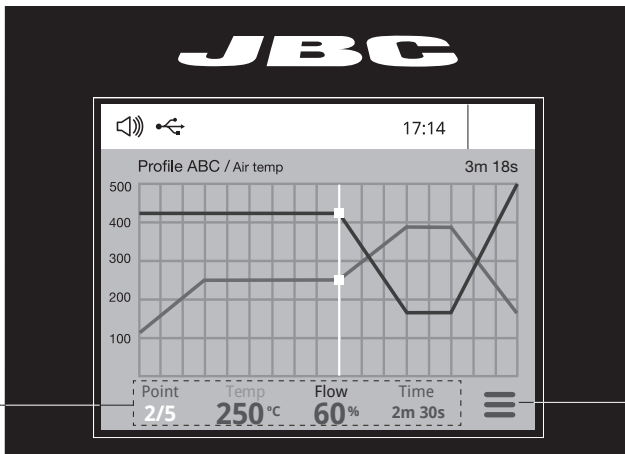

Data for these points

## Menu Options

- Add point
- Delete point
- Load profile
- Save profile
- Exit

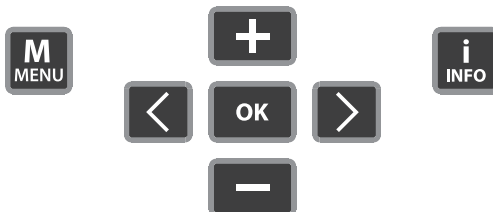



## Process analysis



Graphics

By pressing **Graphics** in the main MENU, temperature and power figures in real time are displayed. This helps you decide which tip to use to obtain the best quality solder joints.

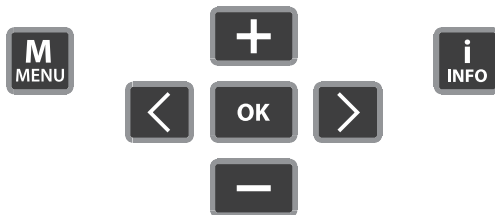
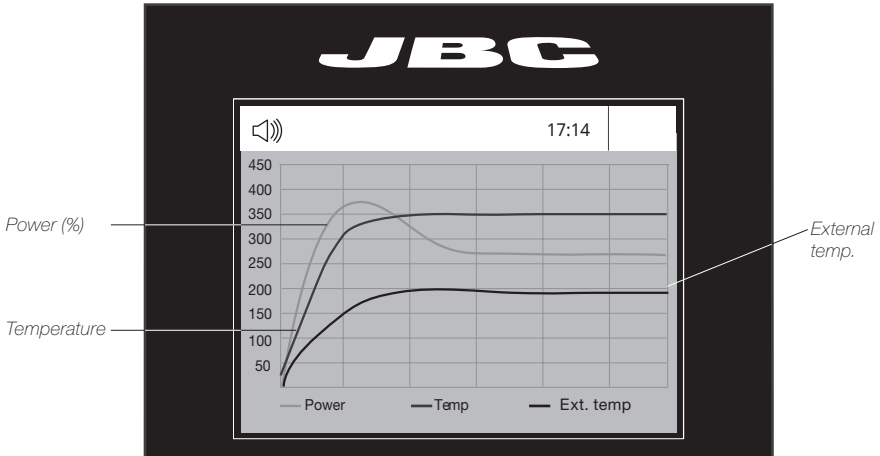

## Files



Files

### Export graphics

Insert a USB flash drive into the USB-A connector to save your soldering process in csv format.

### Export / Import profiles

Insert a USB flash drive into the USB-A connector to export / import profiles.



## Soldering Net (Soon available)

Remotely manage and monitor your stations.

1. Download the **JBC Manager software** and the user manual from [www.jbctools.com/manager.html](http://www.jbctools.com/manager.html)
2. Connect the stations via USB-B connector and the PC will automatically detect them.
3. The notification  will be displayed on the station.

### Functions:

- Set all the station parameters from your PC.
- Organize groups of stations and set all their parameters at the same time.
- Store specific configurations for later use.
- Analyze the soldering graphics of the stations on your PC and export them.

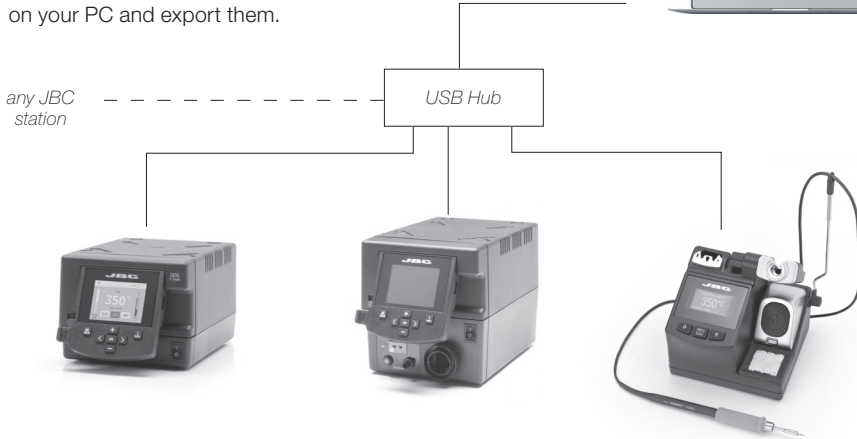

## Update the station software

1. Download the JBC Update File from [www.jbctools.com/software.html](http://www.jbctools.com/software.html) and save it on a USB flash drive. (Preferably one with no other files).

2. Insert the USB flash drive to the station. The icon  is displayed while updating.

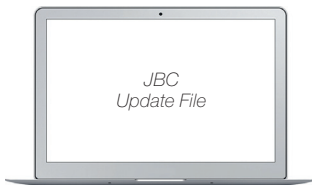

## Replacing the Heating Element

Only perform this operation when the element is cold and the unit is disconnected from the mains.

1. Loosen the screw.
2. Pull the heating element out of the handle.
3. Connect the new heating element, ensuring it is pushed all the way in.
4. Tighten the screw.

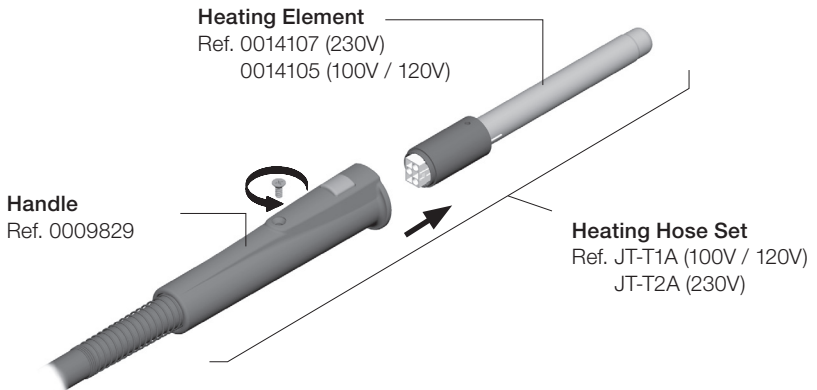

## Changing the JT-TA Heater Hose Set

1. Ensure that the tool is turned off.
2. Use a spanner to unscrew the nut.
3. Make sure that the new heater tube fits into the grooves in the socket.
4. Tighten the screw.

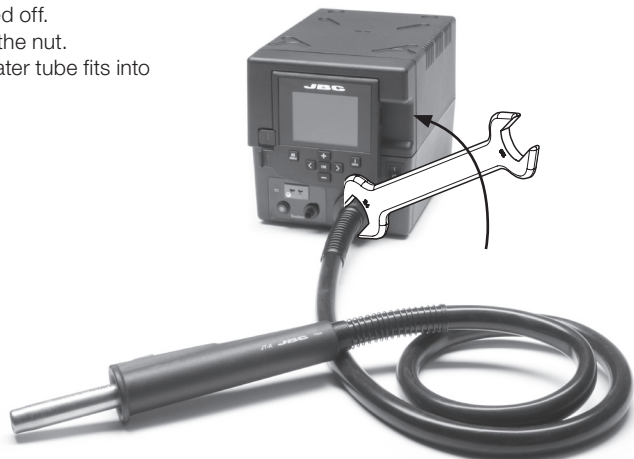

# Hot Air Accessories (not supplied with JT-Q)

Find the model that best suits your soldering needs in [www.jbctools.com](http://www.jbctools.com)

**Protector**



**Tripod**



**Extractor**



**Manual extractor**



**For small components** (fig. 1 and 2).

We recommend using the protector + tripod.

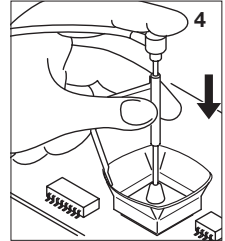
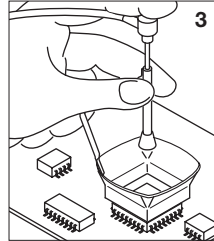
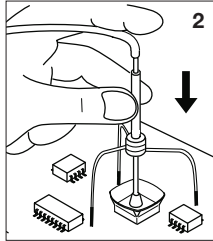
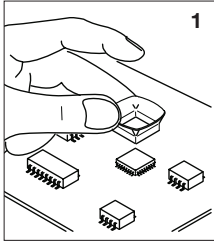

**For big components** (fig. 3 and 4).

We recommend using the extractor.

## Extractor Desk

Ref. 0008752

This accessory lets you quickly switch between different models of extractors and protectors. There are two drawers for storage.



*Protectors and extractors not included.*

## Maintenance

Before carrying out maintenance, always allow the equipment to cool.

- Clean the station screen with a glass cleaner or a damp cloth.
- Use a damp cloth to clean the casing and the tool. Alcohol can only be used to clean the metal parts.
- Periodically check that the metal parts of the tool and stand are clean so that the station can detect the tool status.
- Periodically check all cables and tubes.

*Clean periodically*



- Replace a blown fuse as follows:

1. Pull off the fuse holder and remove the fuse. If necessary use a tool to lever it off.

2. Insert the new fuse into the fuse holder and return it to the station.

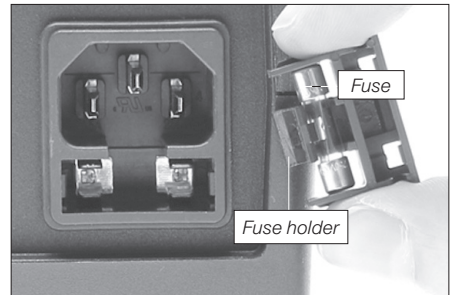
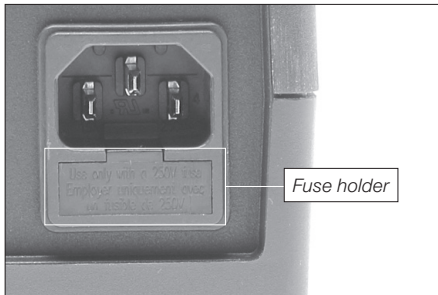

- Replace any defective or damaged pieces. Use original JBC spare parts only.
- Repairs should only be performed by a JBC authorized technical service.

# Safety



**It is imperative to follow safety guidelines to prevent electric shock, injury, fire or explosion.**

- Do not use the units for any purpose other than soldering or rework. Incorrect use may cause fire.
- The power cord must be plugged into approved bases. Make sure that it is properly grounded before use. When unplugging it, hold the plug, not the wire.
- Do not work on electrically live parts.
- The tool should be placed in the stand when not in use to turn off the hot air. The soldering tip, the metal part of the tool and the stand may still be hot even when the station is turned off. Handle with care, including when adjusting the stand position.
- Do not leave the appliance unattended when it is on.
- Do not cover the ventilation grills. Heat can cause inflammable products to ignite.
- Avoid the contact of flux with skin or eyes to prevent irritation
- Be careful with the fumes produced when soldering.
- Keep your workplace clean and tidy. Wear appropriate protection glasses and gloves when working to avoid personal harm.
- Utmost care must be taken with liquid tin waste which can cause burns.
- This appliance can be used by children over the age of eight and also persons with reduced physical, sensory or mental capabilities or lack of experience provided that they have been given adequate supervision or instruction concerning use of the appliance and understand the hazards involved. Children must not play with the appliance.
- Maintenance must not be carried out by children unless supervised.

## Exploded View · Despiece

**JTSE-1QA** 100/120V  
**JTSE-2QA** 230V

HOT AIR STATION  
 WITHOUT EXTRACTOR DESK

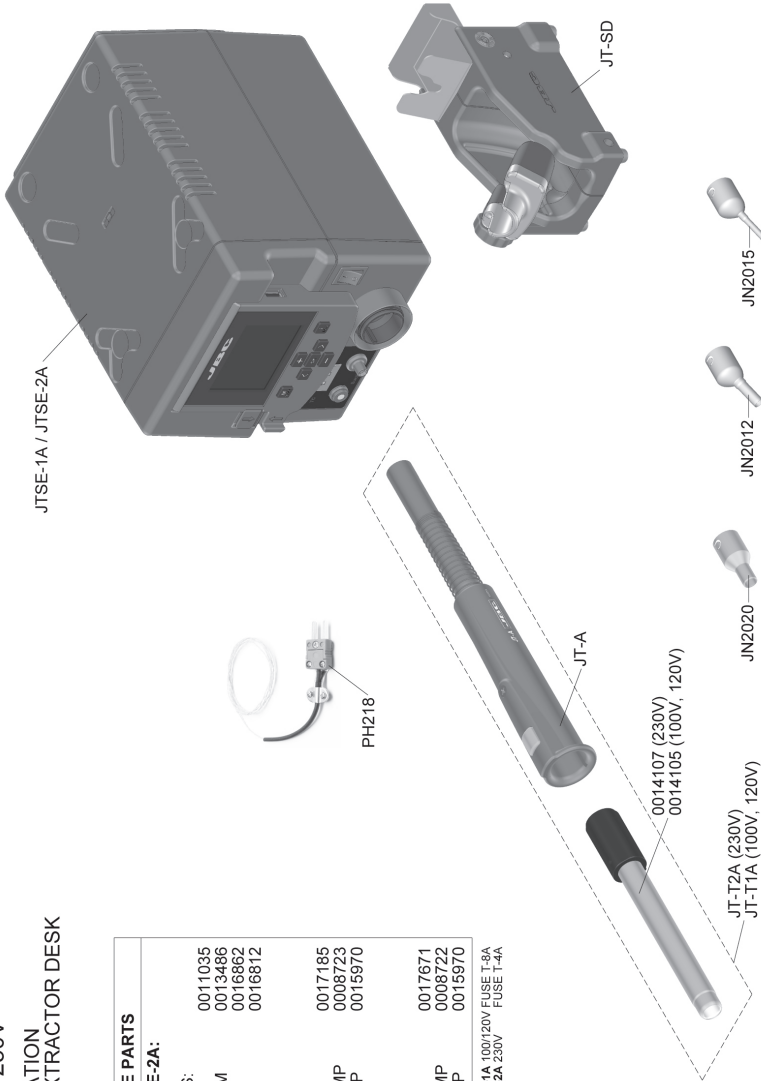

SPARE PARTS	
<b>JTSE-1A / JTSE-2A:</b>	
-ENCLOSURES:	0011035
-TOP	0013486
-BOTTOM	0016862
-FRONT	0016812
-BACK	
<b>JTSE-1A:</b>	
-CIRCUIT	0017185
-SUCTION PUMP	0008723
-HOT AIR PUMP	0015970
<b>JTSE-2A:</b>	
-CIRCUIT	0017671
-SUCTION PUMP	0008722
-HOT AIR PUMP	0015970

JTSE-1A 100/120V FUSE T-8A  
 JTSE-2A 230V FUSE T-4A

# Specifications

**JTSE-1A** 100V - 120V 50/60Hz. Input fuse: 8A. Rated current: 7A

**JTSE-2A** 230V 50/60Hz. Input fuse: 4A. Rated current: 3A

- Weight: 4.104 kg (9.04 lb)
- Dimensions (control unit): 148 x 184 x 140 mm
- Nominal power: 700W
- Temperature selection: Room temp. / 150 - 450 °C (300 - 840 °F)
- Cool mode: T off. Used to blow air to room temperature
- Ambient operating temp: 10 - 40 °C / 50 - 104 °F
- Air flow regulation: 5 - 50 SLPM
- Vacuum: 30% / 228 mmHg / 9 inHg
- Connectors: USB station-PC  
Robot RS232  
P-005 Pedal

Complies with CE standards  
ESD protected housing "skin effect"

# JBC

## Warranty

JBC's 2 year warranty covers this equipment against all manufacturing defects, including the replacement of defective parts and labour.

Warranty does not cover product wear or misuse.

In order for the warranty to be valid, equipment must be returned, postage paid, to the dealer where it was purchased.



This product should not be thrown in the garbage.

In accordance with the European directive 2002/96/EC, electronic equipment at the end of their life must be collected and returned to an authorized recycling facility.



Manual in other languages available on our website

**www.jbctools.com**